



EMF



FOOD MACHINERY

CADENAS DE RODILLOS

ROLLER CHAINS

CHAÎNES À ROULEAUX

DIN 8187 Serie europea European series / <i>Série européenne</i>	13
DIN 8188 Serie americana American series / <i>Série américaine</i>	16
Serie americana reforzada American series reinforced / <i>Série américaine renforcée</i>	19
Con mallas rectas With straight plates / <i>Avec plaques droites</i>	20
De giro lateral Side bow / <i>Flexion latérale</i>	21
Con aletas With attachments / <i>Avec équerres</i>	22
Con pivotes With extended pins / <i>Avec axes débordants</i>	26
Con puente de goma With rubber blocks / <i>Avec taquets caoutchouc</i>	27
Con puente metálico tipo "U" With "U" type attachments / <i>Avec équerres type "U"</i>	28
Doble paso Double pitch / <i>Double pas</i>	29
De eje hueco Hollow pin / <i>Axe creux</i>	35
Cadenas agrícolas Agricultural chains / <i>Chaînes agricoles</i>	37
De acero inoxidable Stainless steel / <i>Acier inox</i>	38
De acero inoxidable de doble paso Stainless steel double pitch / <i>Acier inox double pas</i>	39
De acero inoxidable de eje hueco Stainless steel hollow pin / <i>Acier inox axe creux</i>	40

ESLABONES PARA CADENAS DE RODILLOS

Links for roller chains

Maillons pour Chaînes à rouleaux



Enganche para remachar

Outer link
Maillon extérieur

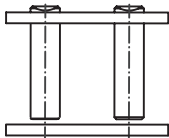
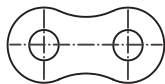

Interior

Inner link
Maillon intérieur

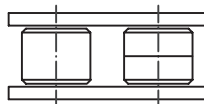
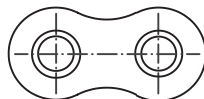

Unión con clip

Connecting link with clip
Maillon avec clip

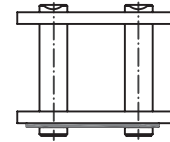
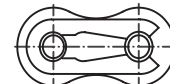

Unión con pasador

Connecting link with cotter
Maillon avec goupille

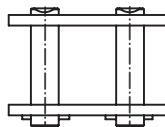
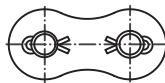

Unión acodada

Offset link
Maillon coudé

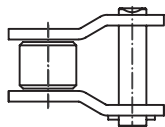
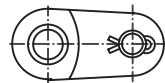

Acodado de 3 rodillos

Double offset link
Maillon coudé double

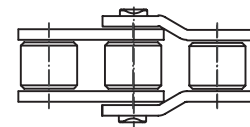
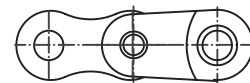

CADENAS DE RODILLOS SIMPLE DIN 8187 SERIE EUROPEA

Simple roller chains DIN 8187 european series

Chaînes à rouleaux simple DIN 8187 série européenne

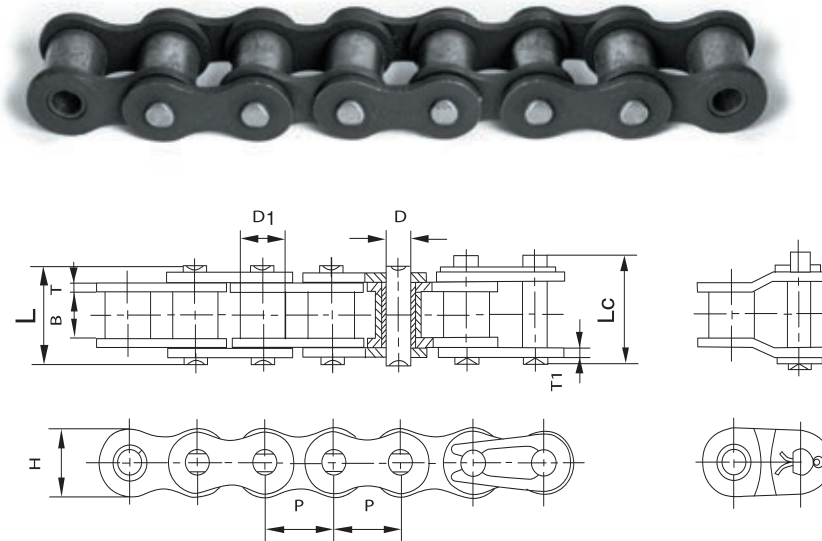

Cadenas de rodillos simples - Serie B

Simple roller chains - B Series

Chaînes à rouleaux simple - Série B

Referencia Reference Référence	Paso Pitch Pas	Ancho interior Inner width Largeur intérieur	Ø Rodillo Roller Rouleau	Ø Eje Pin Axe	Longitud eje Pin length Longueur axe	Ancho malla Plate width Largeur plaques	Espesor malla Plate thickness Épaisseur plaques	Carga de rotura Breaking load Charge rupture	Peso por metro Weight per meter Poids par mètre
DIN/ISO	P mm	B min mm	D1 max mm	D max mm	L max mm Lc max mm	H max mm	T/T1 max mm	Q min KN	q Kg/m
04B-1	6,000	2,80	4,00	1,85	6,80 7,8	5,00	0,60	3,0	0,11
05B-1	8,000	3,00	5,00	2,31	8,20 8,9	7,10	0,80	5,0	0,20
*06B-1	9,525	5,72	6,35	3,28	13,15 14,1	8,20	1,30	9,0	0,41
081-1	12,700	3,30	7,75	3,65	10,20 11,70	9,91	0,95	8,2	0,30
083-1	12,700	4,88	7,75	4,09	12,90 14,40	10,30	1,20	12,0	0,42
08B-1	12,700	7,75	8,51	4,45	16,70 18,2	11,80	1,60	18,0	0,69
10B-1	15,875	9,65	10,16	5,08	19,50 20,9	14,70	1,70	22,4	0,93
12B-1	19,050	11,68	12,07	5,72	22,50 24,2	16,00	1,85	29,0	1,15
16B-1	25,400	17,02	15,88	8,28	36,10 37,4	21,00	4,15/3,1	60,0	2,71
20B-1	31,750	19,56	19,05	10,19	41,30 45,0	26,40	4,5/3,5	95,0	3,70
24B-1	38,100	25,40	25,40	14,63	53,40 57,8	33,20	6,0/4,8	160,0	7,10
28B-1	44,450	30,99	27,94	15,90	65,10 69,5	36,70	7,5/6,0	200,0	8,50
32B-1	50,800	30,99	29,21	17,81	66,00 71,0	42,00	7,0/6,0	250,0	10,25
40B-1	63,500	38,10	39,37	22,89	82,20 89,2	52,96	8,5/8,0	355,0	16,35
48B-1	76,200	45,72	48,26	29,24	99,10 107,0	63,80	12/10	560,0	25,00
56B-1	88,900	53,34	53,98	34,32	114,60 123,00	77,80	13,5/12,0	850,00	35,78
64B-1	101,600	60,96	63,50	39,40	130,00 138,50	90,17	15,0/13,0	1.100,00	46,00
72B-1	114,300	68,58	72,39	44,48	147,40 156,40	103,60	17,0/15,0	1.400,00	60,80

* Malla recta / Straight plates / Plaques droites

CADENAS DE RODILLOS DOBLE DIN 8187 SERIE EUROPEA

Double roller chains DIN 8187 european series

Chaînes à rouleaux doubles DIN 8187 série européenne

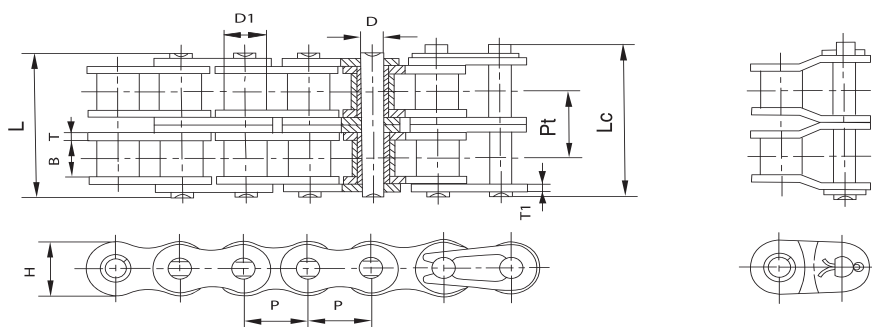

Cadenas de rodillos dobles - serie B

Double roller chains - B series

Chaînes à rouleaux doubles - Série B

Referencia Reference Référence	Paso Pitch Pas	Ancho interior Inner width Largeur intérieur	Ø Rodillo Roller Rouleau	Ø Eje Pin Axe	Longitud eje Pin length Longueur axe		Ancho malla Plate width Largeur plaques	Espesor malla Plate thickness Épaisseur plaques	Paso transversal Transverse pitch Pas transversal	Carga de rotura Breaking load Charge rupture	Peso por metro Weight per meter Poids par mètre
DIN/ISO	P	B min	D1 max	D max	L max	Lc max	H max	T/T1 max	Pt	Q min	q
	mm	mm	mm	mm	mm	mm	mm	mm	mm	KN	Kg/m
05B-2	8,000	3,00	5,00	2,31	13,9	14,5	7,10	0,80	5,64	7,8	0,33
*06B-2	9,525	5,72	6,35	3,28	23,4	24,4	8,20	1,30	10,24	16,9	0,77
08B-2	12,700	7,75	8,51	4,45	31,2	32,2	11,80	1,60	13,92	32,0	1,34
10B-2	15,875	9,65	10,16	5,08	36,1	37,5	14,70	1,70	16,59	44,5	1,84
12B-2	19,050	11,68	12,07	5,72	42,0	43,6	16,00	1,85	19,46	57,8	2,31
16B-2	25,400	17,02	15,88	8,28	68,0	69,3	21,00	4,15/3,1	31,88	106,0	5,42
20B-2	31,750	19,56	19,05	10,19	77,8	81,5	26,40	4,5/3,5	36,45	170,0	7,20
24B-2	38,100	25,40	25,40	14,63	101,7	106,2	33,20	6,0/4,8	48,36	280,0	13,40
28B-2	44,450	30,99	27,94	15,90	124,6	129,1	36,70	7,5/6,0	59,56	360,0	16,60
32B-2	50,800	30,99	29,21	17,81	124,6	129,6	42,00	7,0/6,0	58,55	450,0	21,00
40B-2	63,500	38,10	39,37	22,89	154,5	161,5	52,96	8,5/8,0	72,29	630,0	32,00
48B-2	76,200	45,72	48,26	29,24	190,4	198,2	63,80	12/10	91,21	1.000,0	50,00
56B-2	88,900	53,34	53,98	34,32	221,20	229,60	77,80	13,5/12,0	106,60	1.600,00	71,48
64B-2	101,600	60,96	63,50	39,40	249,90	258,40	90,17	15,0/13,0	119,89	2.000,00	91,00
72B-2	114,300	68,58	72,39	44,48	283,70	292,70	103,60	17,0/15,0	136,27	2.500,00	120,40

* Malla recta / Straight plates / Plaques droites

CADENAS DE RODILLOS TRIPLE DIN 8187 SERIE EUROPEA

Triple roller chains DIN 8187 european series

Chaînes à rouleaux triples DIN 8187 série européenne

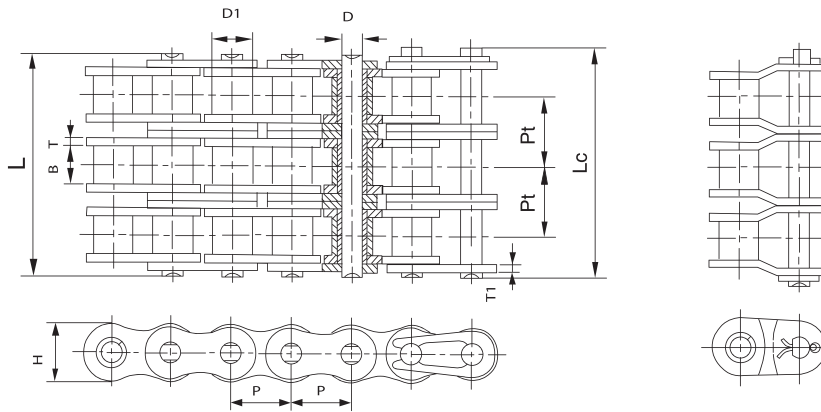

Cadenas de rodillos triples - Serie B

Triple roller chains - B Series

Chaînes à rouleaux triples - Série B

Referencia Reference Référence	Paso Pitch Pas	Ancho interior Inner width Largeur intérieure	Ø Rodillo Roller Rouleau	Ø Eje Pin Axe	Longitud eje Pin length Longueur axe		Ancho malla Plate width Largeur plaques	Espesor malla Plate thickness Épaisseur plaques	Paso transversal Transverse pitch Pas transversal	Carga de rotura Breaking load Charge rupture	Peso por metro Weight per meter Poids par mètre
DIN/ISO	P mm	B min mm	D1 max mm	D max mm	L max mm	Lc max mm	H max mm	T/T1 max mm	Pt mm	Q min KN	q Kg/m
05B-3	8,000	3,00	5,00	2,31	19,5	20,2	7,10	0,80	5,64	11,1	0,48
*06B-3	9,525	5,72	6,35	3,28	33,5	34,6	8,20	1,30	10,24	24,9	1,16
08B-3	12,700	7,75	8,51	4,45	45,1	46,1	11,80	1,60	13,92	47,5	2,03
10B-3	15,875	9,65	10,16	5,08	52,7	54,1	14,70	1,70	16,59	66,7	2,77
12B-3	19,050	11,68	12,07	5,72	61,5	63,1	16,00	1,85	19,46	86,7	3,46
16B-3	25,400	17,02	15,88	8,28	99,8	101,2	21,00	4,15/3,1	31,88	160,0	8,13
20B-3	31,750	19,56	19,05	10,19	114,2	117,9	26,40	4,5/3,5	36,45	250,0	10,82
24B-3	38,100	25,40	25,40	14,63	150,1	154,6	33,20	6,0/4,8	48,36	425,0	20,10
28B-3	44,450	30,99	27,94	15,90	184,2	188,7	36,70	7,5/6,0	59,56	530,0	24,92
32B-3	50,800	30,99	29,21	17,81	183,2	188,2	42,00	7,0/6,0	58,55	670,0	31,56
40B-3	63,500	38,10	39,37	22,89	226,8	233,8	52,96	8,5/8,0	72,29	950,0	48,10
48B-3	76,200	45,72	48,26	29,24	281,6	289,4	63,80	12/10	91,21	1.500,0	75,00
56B-3	88,900	53,34	53,98	34,32	327,80	336,20	77,80	13,5/12,0	106,60	2.240,00	107,18
64B-3	101,600	60,96	63,50	39,40	369,80	378,30	90,17	15,0/13,0	119,89	3.000,00	136,00
72B-3	114,300	68,58	72,39	44,48	420,00	429,00	103,60	17,0/15,0	136,27	3.750,00	180,00

* Malla recta / Straight plates / Plaques droites

CADENAS DE RODILLOS SIMPLE DIN 8188 SERIE AMERICANA

Simple roller chains DIN 8188 american series

Chaînes à rouleaux simple DIN 8188 série américaine

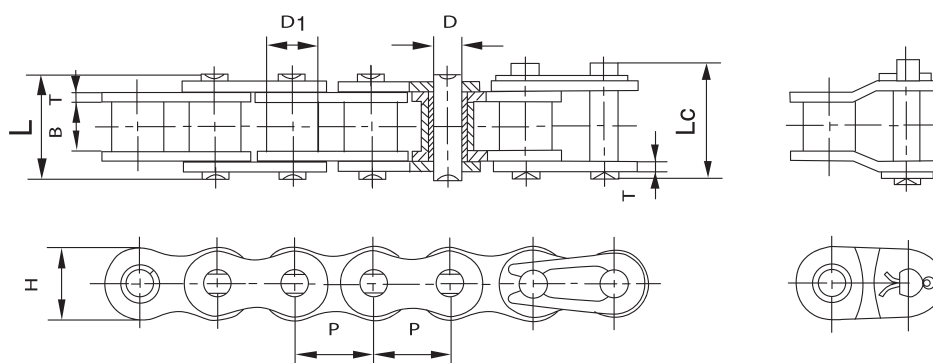

Cadenas de rodillos simples - Serie A

Simple roller chains - A Series

Chaînes à rouleaux simple - Série A

Referencia Reference Référence	Paso Pitch Pas	Ancho interior Inner width Largeur intérieure	Ø Rodillo Roller Rouleau	Ø Eje Pin Axe	Longitud eje Pin length Longueur axe	Ancho malla Plate width Largeur plaques	Espesor malla Plate thickness Épaisseur plaques	Carga de rotura Breaking load Charge rupture	Peso por metro Weight per meter Poids par mètre		
DIN/ISO	ASA	P	B min	D1 max	D max	L max	Lc max	H max	T max	Q min	q
		mm	mm	mm	mm	mm	mm	mm	mm	KN	Kg/m
*04C-1	*25-1	6,350	3,18	3,30	2,31	7,90	8,40	6,00	0,80	3,20	0,15
*06C-1	*35-1	9,525	4,77	5,08	3,58	12,40	13,17	9,00	1,30	7,90	0,33
085-1	41-1	12,700	6,25	7,77	3,58	13,75	15,00	9,91	1,30	6,67	0,41
08A-1	40-1	12,700	7,85	7,95	3,96	16,60	17,80	12,00	1,50	14,10	0,62
10A-1	50-1	15,875	9,40	10,16	5,08	20,70	22,20	15,09	2,03	22,20	1,02
12A-1	60-1	19,050	12,57	11,91	5,94	25,90	27,70	18,00	2,42	31,80	1,50
16A-1	80-1	25,400	15,75	15,88	7,92	32,70	35,00	24,00	3,25	56,70	2,60
20A-1	100-1	31,750	18,90	19,05	9,53	40,40	44,70	30,00	4,00	88,50	3,91
24A-1	120-1	38,100	25,22	22,23	11,10	50,30	54,30	35,70	4,80	127,00	5,62
28A-1	140-1	44,450	25,22	25,40	12,70	54,40	59,00	41,00	5,60	172,40	7,50
32A-1	160-1	50,800	31,55	28,58	14,27	64,80	69,60	47,80	6,40	226,80	10,10
40A-1	200-1	63,500	37,85	39,68	19,85	80,30	87,20	60,00	8,00	353,80	16,15
48A-1	240-1	76,200	47,35	47,63	23,81	95,50	103,00	72,39	9,50	510,30	23,20

* Cadena de casquillo fijo / Bush chains / Chaîne à douilles

CADENAS DE RODILLOS DOBLE DIN 8188 SERIE AMERICANA

Double roller chains DIN 8188 american series

Chaînes à rouleaux doubles DIN 8188 série américaine

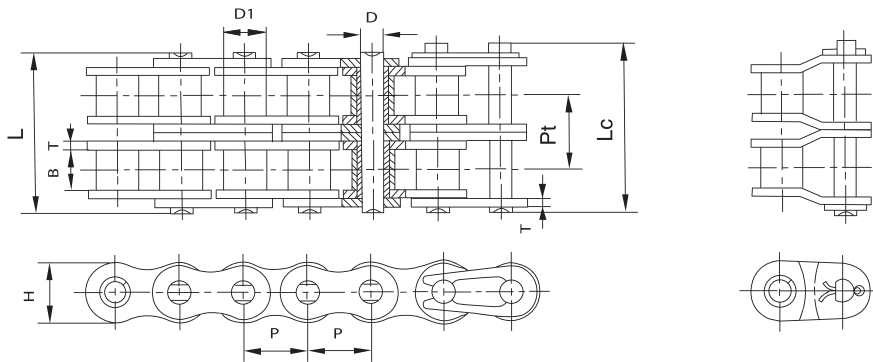

Cadenas de rodillos dobles - Serie A

Double roller chains - A Series

Chaînes à rouleaux doubles - Série A

Referencia Reference Référence	Paso Pitch Pas	Ancho interior Inner width Largeur intérieure	Ø Rodillo Roller Rouleau	Ø Eje Pin Axe	Longitud eje Pin length Longueur axe	Ancho malla Plate width Largeur plaques	Espesor malla Plate thickness Épaisseur plaques	Paso transversal Transverse pitch Pas transversal	Carga de rotura Breaking load Charge rupture	Peso por metro Weight per meter Poids par mètre		
DIN/ISO	ASA	P	B min	D1 max	D max	L max	Lc max	H max	T max	Pt	Q min	q
		mm	mm	mm	mm	mm	mm	mm	mm	mm	KN	Kg/m
*04C-2	*25-2	6,350	3,18	3,30	2,31	14,50	15,00	6,00	0,80	6,40	7,00	0,28
*06C-2	*35-2	9,525	4,77	5,08	3,58	22,50	23,30	9,00	1,30	10,13	15,80	0,63
085-2	41-2	12,700	6,25	7,77	3,58	25,70	26,90	9,91	1,30	11,95	13,34	0,81
08A-2	40-2	12,700	7,85	7,95	3,96	31,00	32,20	12,00	1,50	14,38	28,20	1,12
10A-2	50-2	15,875	9,40	10,16	5,08	38,90	40,40	15,09	2,03	18,11	44,40	2,00
12A-2	60-2	19,050	12,57	11,91	5,94	48,80	50,50	18,00	2,42	22,78	63,60	2,92
16A-2	80-2	25,400	15,75	15,88	7,92	62,70	64,30	24,00	3,25	29,29	113,40	5,15
20A-2	100-2	31,750	18,90	19,05	9,53	76,40	80,50	30,00	4,00	35,76	177,00	7,80
24A-2	120-2	38,100	25,22	22,23	11,10	95,80	99,70	35,70	4,80	45,44	254,00	11,70
28A-2	140-2	44,450	25,22	25,40	12,70	103,30	107,90	41,00	5,60	48,87	344,80	15,14
32A-2	160-2	50,800	31,55	28,58	14,27	123,30	128,10	47,80	6,40	58,55	453,60	20,14
40A-2	200-2	63,500	37,85	39,68	19,85	151,90	158,80	60,00	8,00	71,55	707,60	32,24
48A-2	240-2	76,200	47,35	47,63	23,81	183,40	190,80	72,39	9,50	87,83	1.020,60	45,23

* Cadena de casquillo fijo / Bush chains / Chaîne à douilles

CADENAS DE RODILLOS SERIE AMERICANA REFORZADA

Roller chains american series reinforced

Chaînes à rouleaux série américaine renforcée

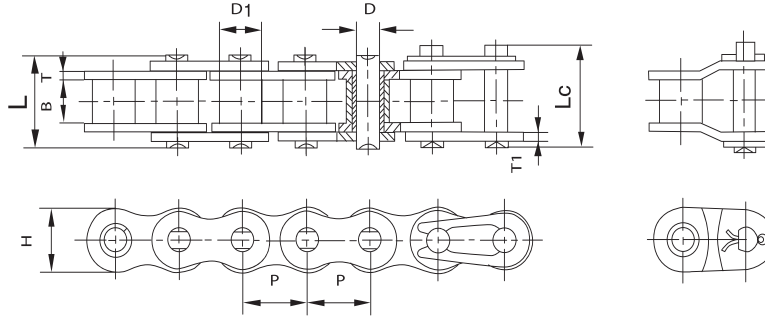

Referencia Reference Référence		Paso Pitch Pas	Ancho interior Inner width Largeur intérieur	Ø Rodillo Rouleau	Ø Eje Pin Axe	Longitud eje Pin length Longueur axe	Ancho malla Plate width Largeur plaques	Espesor malla Plate thickness Épaisseur plaques	Paso transversal Transverse pitch Pas transversal	Carga de rotura Breaking load Charge rupture	Peso por metro Weight per meter Poids par mètre	
DIN/ISO	ANSI	P mm	B min	D1 max mm	D max mm	L max mm	Lc max mm	H max mm	T max mm	Pt mm	Q min KN	q Kg/m
	*35H-1	9.525	4.77	5.08	3.58	13.3	14.3	9.00	1.50		10.8	0.41
08AH-1	40H-1	12.700	7.85	7.95	3.96	18.8	19.9	12.00	2.03		19.1	0.82
10AH-1	50H-1	15.875	9.40	10.16	5.08	22.1	23.4	15.09	2.42		30.2	1.25
12AH-1	60H-1	19.050	12.57	11.91	5.94	29.2	31.0	18.00	3.25		42.7	1.87
16AH-1	80H-1	25.400	15.75	15.88	7.92	36.2	37.7	24.00	4.00		71.4	3.10
20AH-1	100H-1	31.750	18.90	19.05	9.53	43.6	46.9	30.00	4.80		112.4	4.52
24AH-1	120H-1	38.100	25.22	22.23	11.10	53.5	57.5	35.70	5.60		160.9	6.60
28AH-1	140H-1	44.450	25.22	25.40	12.70	57.6	62.2	41.00	6.40		217.3	8.30
32AH-1	160H-1	50.800	31.55	28.58	14.27	68.2	73.0	47.80	7.20		285.8	10.30
36AH-1	180H-1	57.150	35.48	35.71	17.46	75.9	81.6	53.60	8.00		341.8	14.83
40AH-1	200H-1	63.500	37.85	39.68	19.85	86.6	93.5	60.00	9.50		444.5	19.16
48AH-1	240H-1	76.200	47.35	47.63	23.81	109.6	115.9	72.30	12.70		622.5	30.40
12AH-2	60H-2	19.050	12.57	11.91	5.94	55.3	57.1	18.00	3.25	26.11	84.5	3.71
16AH-2	80H-2	25.400	15.75	15.88	7.92	68.8	70.3	24.00	4.00	32.59	145.3	6.15
20AH-2	100H-2	31.750	18.90	19.05	9.53	82.7	86.0	30.00	4.80	39.09	225.9	9.03
24AH-2	120H-2	38.100	25.22	22.23	11.10	102.4	106.4	35.70	5.60	48.87	322.7	13.13
28AH-2	140H-2	44.450	25.22	25.40	12.70	109.8	114.4	41.00	6.40	52.20	437.7	16.60
32AH-2	160H-2	50.800	31.55	28.58	14.27	130.1	134.9	47.80	7.20	61.90	571.6	20.20
40AH-2	200H-2	63.500	37.85	39.68	19.85	164.9	171.8	60.00	9.50	78.31	894.9	38.11
12AH-3	60H-3	19.050	12.57	11.91	5.94	81.4	83.2	18.00	3.25	26.11	113.9	5.54
16AH-3	80H-3	25.400	15.75	15.88	7.92	101.4	102.9	24.00	4.00	32.59	203.5	9.42
20AH-3	100H-3	31.750	18.90	19.05	9.53	121.8	125.1	30.00	4.80	39.09	314.8	12.96
24AH-3	120H-3	38.100	25.22	22.23	11.10	151.2	155.2	35.70	5.60	48.87	444.7	19.64
28AH-3	140H-3	44.450	25.22	25.40	12.70	162.0	166.6	41.00	6.40	52.20	598.4	24.90
32AH-3	160H-3	50.800	31.55	28.58	14.27	192.0	196.8	47.80	7.20	61.90	787.3	30.10
40AH-3	200H-3	63.500	37.85	39.68	19.85	243.2	250.1	60.00	9.50	78.31	1228.2	57.06

CADENAS DE RODILLOS CON MALLAS RECTAS

Roller chains with straight plates

Chaînes à rouleaux avec plaques droites

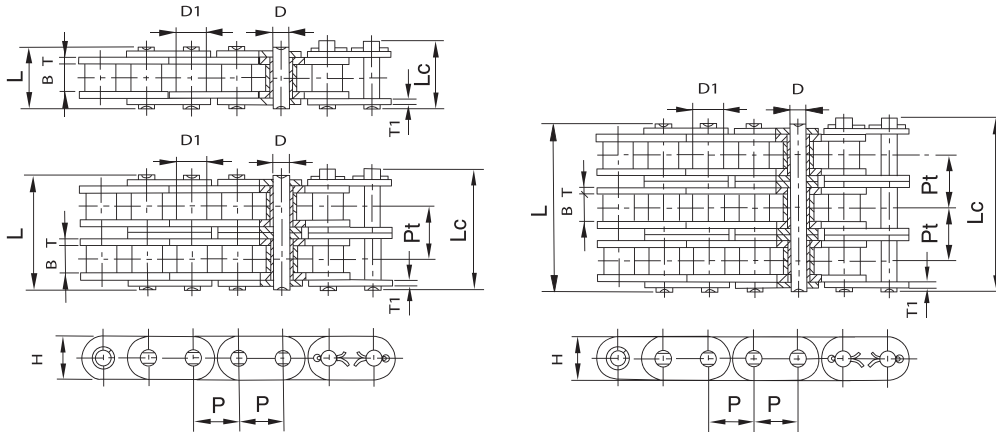

Referencia Reference Référence	Paso Pitch Pas	Ancho interior Inner width Largeur intérieure	Ø Rodillo Roller Rouleau	Ø Eje Pin Axe	Longitud eje Pin length Longueur axe		Ancho malla Plate width Largeur plaques	Espesor malla Plate thickness Épaisseur plaques	Paso transversal Transverse pitch Pas transversal	Carga de rotura Breaking load Charge rupture	Peso por metro Weight per meter Poids par mètre
DIN/ISO	P mm	B min mm	D1 max mm	D max mm	L max mm	Lc max mm	H max mm	T/T1 max mm	Pt mm	Q min KN	q Kg/m
C08B-1	12,700	7,75	8,51	4,45	16,7	18,2	11,8	1,60		18,0	0,80
C10B-1	15,875	9,65	10,16	5,08	19,5	20,9	14,7	1,70		22,4	1,06
C12B-1	19,050	11,68	12,07	5,72	22,5	25,2	16,0	1,85		29,0	1,32
C16B-1	25,400	17,02	15,88	8,28	36,1	39,1	21,0/24,0	4,15/3,1		60,0	3,08/3,49
C20B-1	31,750	19,56	19,05	10,19	41,3	45,0	26,4	4,5/3,5		95,0	4,16
C24B-1	38,100	25,40	25,40	14,63	53,4	57,8	33,2	6,0/4,8		160,0	7,47
C28B-1	44,450	30,99	27,94	15,90	65,1	69,5	36,7	7,5/6,0		200,0	9,90
C32B-1	50,800	30,99	29,21	17,81	66,0	71,0	42,0	7,0/6,0		250,0	10,45
C08B-2	12,700	7,75	8,51	4,45	31,2	32,2	11,8	1,60	13,92	32,0	1,45
C10B-2	15,875	9,65	10,16	5,08	36,1	37,5	14,7	1,70	16,59	44,5	2,00
C12B-2	19,050	11,68	12,07	5,72	42,0	44,7	16,0	1,85	19,46	57,8	2,62
C16B-2	25,400	17,02	15,88	8,28	68,0	71,0	21,0/24,0	4,15/3,1	31,88	106,0	6,10/6,92
C20B-2	31,750	19,56	19,05	10,19	77,8	81,5	26,4	4,5/3,5	36,45	170,0	8,23
C24B-2	38,100	25,40	25,40	14,63	101,7	106,2	33,2	6,0/4,8	48,36	280,0	14,77
C28B-2	44,450	30,99	27,94	15,90	124,6	129,1	36,7	7,5/6,0	59,56	360,0	19,82
C32B-2	50,800	30,99	29,21	17,81	124,6	129,6	42,0	7,0/6,0	58,55	450,0	20,94
C08B-3	12,700	7,75	8,51	4,45	45,1	46,1	11,8	1,60	13,92	47,5	2,10
C10B-3	15,875	9,65	10,16	5,08	52,7	54,1	14,7	1,70	16,59	66,7	2,87
C12B-3	19,050	11,68	12,07	5,72	61,5	64,2	16,0	1,85	19,46	86,7	3,89
C16B-3	25,400	17,02	15,88	8,28	99,8	102,9	21,0/24,0	4,15/3,1	31,88	160,0	9,12/10,34
C20B-3	31,750	19,56	19,05	10,19	114,2	117,9	26,4	4,5/3,5	36,45	250,0	11,34
C24B-3	38,100	25,40	25,40	14,63	150,1	154,6	33,2	6,0/4,8	48,36	425,0	22,10
C28B-3	44,450	30,99	27,94	15,90	184,2	188,7	36,7	7,5/6,0	59,56	530,0	29,64
C32B-3	50,800	30,99	29,21	17,81	183,2	188,2	42,0	7,0/6,0	58,55	670,0	31,27

CADENAS DE RODILLOS DE GIRO LATERAL

Side bow roller chains

Chaînes à rouleaux flexion latérale

1

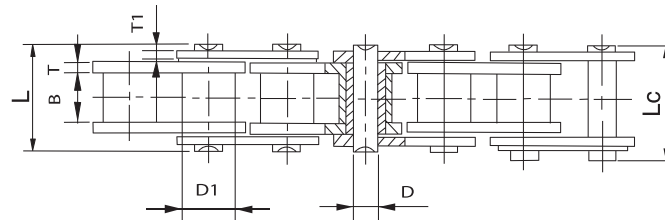
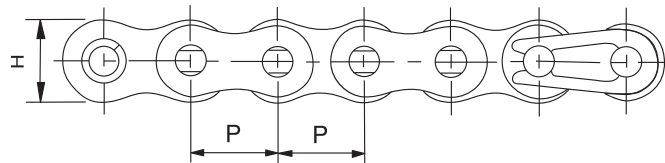
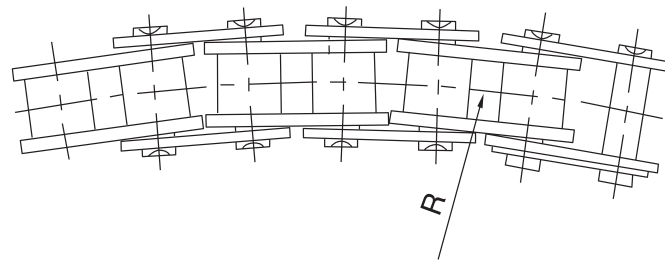

Referencia Reference Référence	Paso Pitch Pas	Ancho interior Inner width Largeur intérieur	Ø Rodillo Roller Rouleau	Ø Eje Pin Axe	Longitud eje Pin length Longueur axe		Ancho malla Plate width Largeur plaques	Espesor malla Plate thickness Épaisseur plaques	Radio de giro Side bow radius Rayon courbure latéral	Carga de rotura Breaking load Charge rupture	Peso por metro Weight per meter Poids par mètre
ANSI/ISO	P	B min	D1 max	D max	L max	Lc max	H max	T/T1 max	R min	Q min	q
	mm	mm	mm	mm	mm	mm	mm	mm	mm	KN	Kg/m
40SB	12,700	7,85	7,95	3,96	16,90	18,10	11,70	1,50	350,00	13,80	0,80
50SB	15,875	9,40	10,16	4,37	20,70	22,70	14,90	2,03	400,00	20,60	1,09
60SB	19,050	12,57	11,91	5,34	26,60	28,40	18,00	2,42	500,00	15,70	1,54
80SB	25,400	15,75	15,88	7,19	34,00	37,30	24,00	3,25	715,00	40,90	2,60
08BSB	12,700	7,75	8,51	3,97	17,40	18,70	11,80	1,60	400,00	14,00	0,70
10BSB	15,875	9,65	10,16	4,50	20,10	21,50	14,70	1,70	400,00	15,60	0,93
12BSB	19,050	11,68	12,07	5,12	23,10	24,80	16,00	1,85	500,00	20,50	1,16
16BSB	25,400	17,02	15,88	7,90	36,50	39,70	21,00	3,7/3,0	500,00	55,60	2,53

CADENAS DE RODILLOS CON ALETAS

Roller chains with attachments

Chaînes à rouleaux avec équerres

Aleta 90° 1 taladro 1 lado

Attachment 90° 1 hole 1 side

Équerre 90° 1 trou 1 côté



A-1

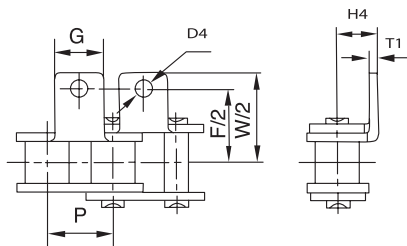

Aleta 90° 1 taladro 2 lados

Attachment 90° 1 hole 2 sides

Équerre 90° 1 trou 2 côtés



K-1

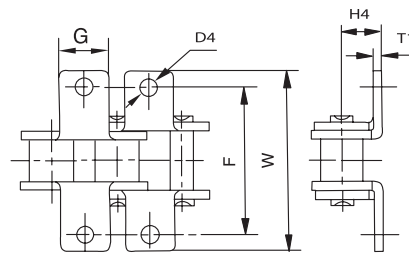

Cadenas de rodillos con aletas estándar ISO - Serie B

Roller chains with attachments standard ISO - B Series

Chaînes à rouleaux avec équerres standard ISO - Série B

Referencia Reference Référence	P	G	F	W	T1	H4	D4
DIN/ISO	mm	mm	mm	mm	mm	mm	mm
*06B	9,525	8,0	19,04	27,0	1,30	6,50	3,5
08B	12,700	9,5	25,40	36,4	1,60	8,90	4,5
10B	15,875	14,3	31,75	44,6	1,70	10,31	5,3
12B	19,050	16,0	38,10	52,4	1,85	13,46	6,4
16B	25,400	19,1	50,80	72,6	3,10	15,88	6,4
20B	31,750	35,0	63,50	100,5	3,50	19,80	9,0
24B	38,100	30,0	76,20	108,4	4,80	26,67	10,5

* Malla recta / Straight plates / Plaques droites

Disponible en acero inoxidable / Also available in stainless steel / Disponible en acier inox

Cadenas de rodillos con aletas especial YUK - Serie B

Roller chains with attachments special YUK - B Series

Chaînes à rouleaux avec équerres spécial YUK - Série B

Referencia Reference Référence	P	G	F	W	T1	H4	D4
DIN/ISO	mm	mm	mm	mm	mm	mm	mm
*06B	9,525	8	19,0	27,0	1,30	6,5	3,5
08B	12,700	11	27,6	38,4	1,60	8,75	4,3
10B	15,875	14	31,6	45,6	1,70	10,5	5,3
12B	19,050	18	35,4	54,8	1,85	11,6	6,4
16B	25,400	24	53,8	77,6	3,10	16,3	8,2
20B	31,750	25	63,0	99	3,50	19,84	9
24B	38,100	30	76,2	118	4,80	26,7	11

* Malla recta / Straight plates / Plaques droites

Disponible en acero inoxidable / Also available in stainless steel / Disponible en acier inox

Para otras medidas consultar / Other measures upon request / Fabrication sur mesure: nous consulter

CADENAS DE RODILLOS CON ALETAS

Roller chains with attachments
Chaînes à rouleaux avec équerres

Aleta vertical 1 taladro 1 lado

Straight attachment 1 hole 1 side
Équerre droite 1 trou 1 côté



SA-1

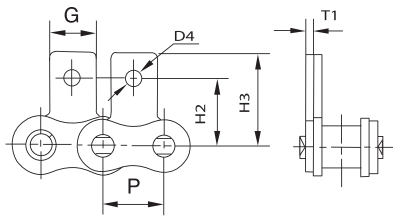

Alerta vertical 1 taladro 2 lados

Straight attachment 1 hole 2 sides
Équerre droite 1 trou 2 côtés



SK-1

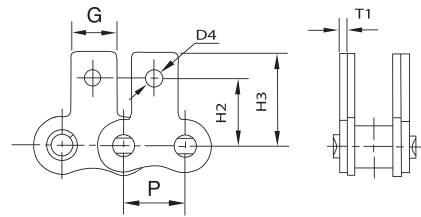

Cadenas de rodillos con aletas estándar ISO - Serie B

Roller chains with attachments standard ISO - B Series
Chaînes à rouleaux avec équerres standard ISO - Série B

Referencia Reference Référence	P	G	H2	H3	T1	D4
DIN/ISO	mm	mm	mm	mm	mm	mm
*06B	9,525	8,0	9,52	13,50	1,30	3,5
08B	12,700	9,5	13,35	18,90	1,60	4,3
10B	15,875	14,3	16,50	22,95	1,70	5,3
12B	19,050	16,0	21,45	28,60	1,85	6,4
16B	25,400	19,1	23,15	34,00	3,10	6,4
20B	31,750	35,0	30,50	45,70	3,50	9,0
24B	38,100	36,0	42,70	61,50	4,80	10,5

* Malla recta / Straight plates / Plaques droites

Disponibile en acero inoxidable / Also available in stainless steel / Disponible en acier inox

Cadenas de rodillos con aletas especial YUK - Serie B

Roller chains with attachments special YUK - B Series
Chaînes à rouleaux avec équerres spécial YUK - Série B

Referencia Reference Référence	P	G	H2	H3	T1	D4
DIN/ISO	mm	mm	mm	mm	mm	mm
*06B	9,525	8	9,5	13,5	1,30	3,5
08B	12,700	11	14,1	19,5	1,60	4,3
10B	15,875	14	16,2	23,2	1,70	5,3
12B	19,050	18	18,2	28,1	1,85	6,4
16B	25,400	24	25,4	37,35	3,10	8,2
20B	31,750	25	31,75	50	3,50	9
24B	38,100	30	36,51	55	4,80	11

* Malla recta / Straight plates / Plaques droites

Disponibile en acero inoxidable / Also available in stainless steel / Disponible en acier inox

Para otras medidas consultar / Other measures upon request / Fabrication sur mesure: nous consulter

CADENAS DE RODILLOS CON ALETAS

Roller chains with attachments

Chaînes à rouleaux avec équerres

Aleta 90° 2 taladros 1 lado

Attachment 90° 2 holes 1 side

Équerre 90° 2 trous 1 côté



Aleta 90° 2 taladros 2 lados

Attachment 90° 2 holes 2 side

Équerre 90° 2 trous 2 côtés



WA-2

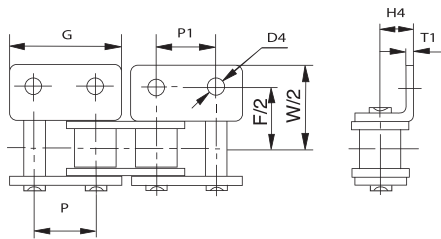

WK-2

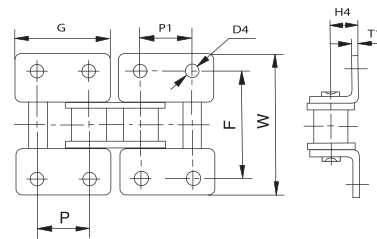

Cadenas de rodillos con aletas estándar ISO - Serie B

Roller chains with attachments standard ISO - B Series

Chaînes à rouleaux avec équerres standard ISO - Série B

Referencia Reference Référence	P	G	P1	F	W	T1	H4	D4
DIN/ISO	mm	mm	mm	mm	mm	mm	mm	mm
*06B	9,525	17,65	9,525	19,05	27,50	1,30	6,50	3,5
08B	12,700	24,00	12,700	25,40	36,4	1,60	8,90	4,3
10B	15,875	29,58	15,875	31,80	44,6	1,70	10,31	5,3
12B	19,050	34,05	19,050	38,10	52,4	1,85	13,46	6,4
16B	25,400	46,40	25,400	50,80	72,6	3,10	15,88	6,4
20B	31,750	58,10	31,750	63,50	100,5	3,50	19,80	9,0
24B	38,100	71,30	38,100	76,20	108,4	4,80	26,67	10,5

* Malla recta / Straight plates / Plaques droites

Disponible en acero inoxidable / Also available in stainless steel / Disponible en acier inox

Cadenas de rodillos con aletas especial YUK - Serie B

Roller chains with attachments special YUK - B Series

Chaînes à rouleaux avec équerres spécial YUK - Série B

Referencia Reference Référence	P	G	P1	F	W	T1	H4	D4
DIN/ISO	mm	mm	mm	mm	mm	mm	mm	mm
*06B	9,525	17,75	9,525	19,0	27,0	1,30	6,5	3,5
08B	12,700	24,2	12,7	27,6	38,4	1,60	8,75	4,3
10B	15,875	29,9	15,875	31,6	45,6	1,70	10,5	5,3
12B	19,050	35,25	19,05	35,4	54,8	1,85	11,6	6,4
16B	25,400	45	25,4	53,8	77,6	3,10	16,3	8,2
20B	31,750	58	31,75	63,0	99	3,50	19,84	9
24B	38,100	72	38,1	76,2	118	4,80	26,7	11

* Malla recta / Straight plates / Plaques droites

Disponible en acero inoxidable / Also available in stainless steel / Disponible en acier inox

Para otras medidas consultar / Other measures upon request / Fabrication sur mesure: nous consulter

CADENAS DE RODILLOS CON ALETAS

Roller chains with attachments
Chaînes à rouleaux avec équerres

Aleta vertical 2 taladros 1 lado
Straight attachment 2 holes 1 side
Équerre droite 2 trous 1 côté



Aleta vertical 2 taladros 2 lados
Straight attachment 2 holes 2 sides
Équerre droite 2 trous 2 côtés

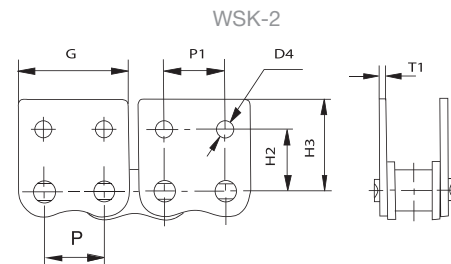
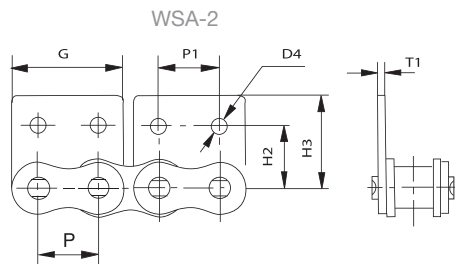

Cadenas de rodillos con aletas estándar ISO - Serie B

Roller chains with attachments standard ISO - B Series
Chaînes à rouleaux avec équerres standard ISO - Série B

Referencia Reference Référence	P	G	P1	H2	H3	T1	D4
DIN/ISO	mm	mm	mm	mm	mm	mm	mm
*06B	9,525	17,65	9,525	9,52	13,50	1,30	3,5
08B	12,700	23,30	12,700	13,35	18,90	1,60	4,3
10B	15,875	29,58	15,875	16,50	22,95	1,70	5,3
12B	19,050	34,05	19,050	21,45	28,60	1,85	6,4
16B	25,400	46,40	25,400	23,15	34,00	3,10	6,4
20B	31,750	58,10	31,750	30,50	45,70	3,50	9,0
24B	38,100	71,30	38,100	42,70	61,50	4,80	10,5

* Malla recta / Straight plates / Plaques droites

Disponibile en acero inoxidable / Also available in stainless steel / Disponible en acier inox

Cadenas de rodillos con aletas especial YUK - Serie B

Roller chains with attachments special YUK - B Series
Chaînes à rouleaux avec équerres spécial YUK - Série B

Referencia Reference Référence	P	G	P1	H2	H3	T1	D4
DIN/ISO	mm	mm	mm	mm	mm	mm	mm
*06B	9,525	17,75	9,525	9,5	13,5	1,30	3,5
08B	12,700	24,2	12,700	14,1	19,5	1,60	4,3
10B	15,875	29,9	15,875	16,2	23,2	1,70	5,3
12B	19,050	35,25	19,050	18,2	28,1	1,85	6,4
16B	25,400	45	25,400	25,4	37,35	3,10	8,2
20B	31,750	58	31,750	31,75	50	3,50	9
24B	38,100	72	38,100	36,51	55	4,80	11

* Malla recta / Straight plates / Plaques droites

Disponibile en acero inoxidable / Also available in stainless steel / Disponible en acier inox

Para otras medidas consultar / Other measures upon request / Fabrication sur mesure: nous consulter

CADENAS DE RODILLOS CON PIVOTES

Roller chains with extended pins

Chaînes à rouleaux avec axes débordants



Cada 2 pasos
Every 2 pitches
Tous les 2 pas

Todos los pasos
Every pitches
Tous les pas

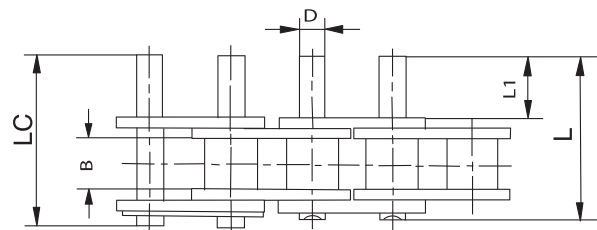
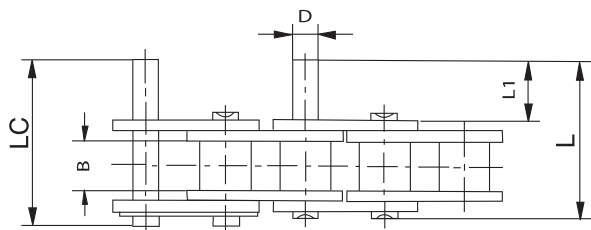
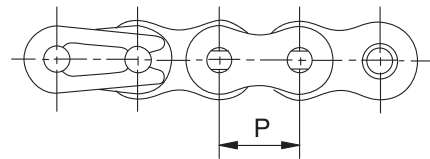
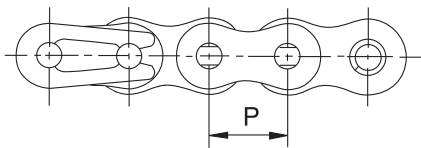

Referencia Reference Référence	P	B	D	L1	L	Lc
DIN/ISO	mm	mm	mm	mm	mm	mm
*06B	9,525	5,72	3,28	11,3	23,4	24,4
08B	12,700	7,75	4,45	15,5	31,2	32,2
10B	15,875	9,65	5,08	17,8	36,1	37,5
12B	19,050	11,68	5,72	20,7	42,0	43,6
16B	25,400	17,02	8,28	33,2	68,0	69,3

* Malla recta / Straight plates / Plaques droites

Disponibile en acero inoxidable / Also available in stainless steel / Disponible en acier inox

Para otras medidas consultar / Other measures upon request / Fabrication sur mesure: nous consulter

CADENAS DE RODILLOS CON PUENTE DE GOMA

Roller chains with rubber blocks

Chaînes à rouleaux avec taquets caoutchouc

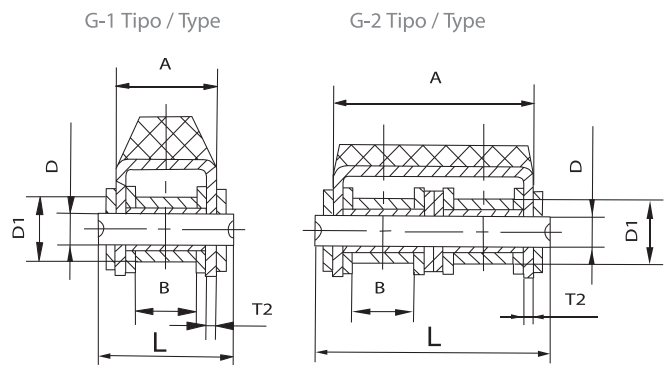
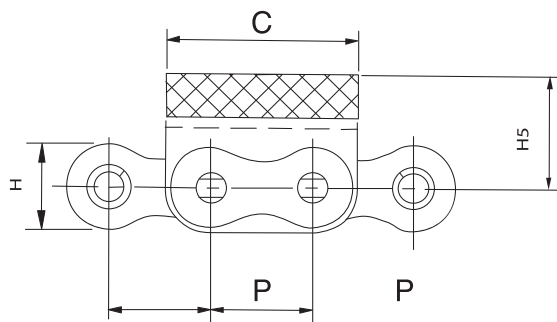
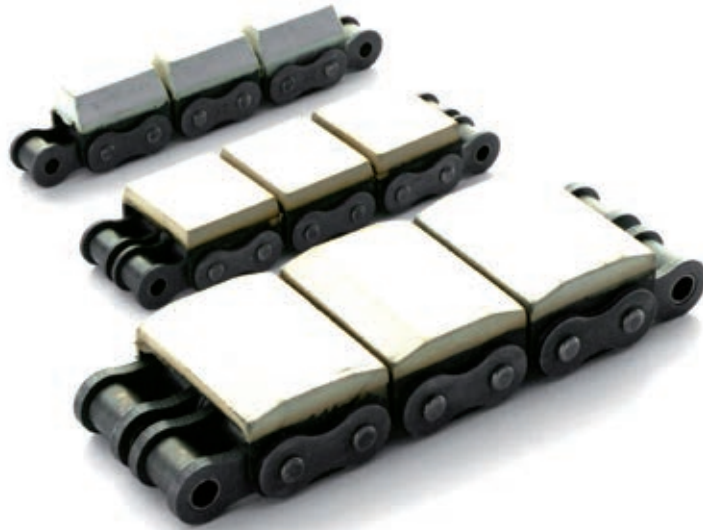

Referencia Reference Référence	Paso Pitch Pas	Ancho interior Inner width Largeur intérieur	Ø Rodillo Roller Rouleau	Ø Eje Pin Axe	Longitud eje Pin length Longueur axe	Dimensiones de malla y puente de goma Plate and rubber blocks dimensions Dimensions plaques et taquets caoutchouc					Carga de rotura Breaking load Charge rupture	Peso por metro Weight per meter Poids par mètre
DIN/ISO	P	B min	D1 max	D max	L max	H max	A	C	H5	T2	Q min	q
	mm	mm	mm	mm	mm	mm	mm	mm	mm	mm	KN	Kg/m
08B-G1	12,70	7,75	8,51	4,45	20,0	11,8	14,6	24,2	12,3	1,60	18,0	1,19
08B-G2	12,70	7,75	8,51	4,45	34,3	11,8	28,4	24,2	12,3	1,50	32,0	2,07
10B-G1	15,875	9,65	10,16	5,08	23,2	14,7	16,8	30,0	17,0	1,60	22,4	1,62
10B-G2	15,875	9,65	10,16	5,08	39,7	14,7	33,3	30,0	17,0	1,50	44,5	2,56
12B-G1	19,05	11,68	12,07	5,72	25,7	16,0	19,6	36,0	21,0	1,85	29,0	2,01
12B-G2	19,05	11,68	12,07	5,72	45,3	16,0	39,1	36,0	16,0	1,85	57,8	3,21
16B-G1	25,40	17,02	15,88	8,28	39,7	21,0	29,1	49,0	21,4	1,60	58,0	3,83
16B-G2	25,40	17,02	15,88	8,28	71,58	21,0	61,0	49,0	21,4	1,60	116,0	7,32
16A-G1	25,40	15,75	15,88	7,92	37,2	24,0	27,5	46,0	20,0	2,42	42,0	3,97
20B-G1	31,75	19,56	19,05	10,19	48,0	26,4	36,0	57,0	27,0	3,50	85,0	6,19
24B-G1	38,10	25,40	25,40	14,63	61,6	33,2	47,0	72,6	34,0	4,50	160,0	11,25

CADENAS DE RODILLOS CON PUENTE METÁLICO TIPO “U”

Roller chains with “U” type attachments

Chaînes à rouleaux avec équerres type “U”

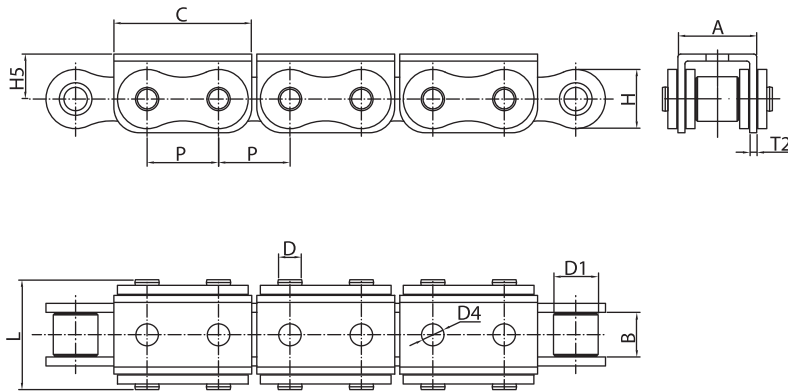

Referencia Reference Référence	Paso Pitch Pas	Ancho interior Inner width Largeur intérieur	Ø Rodillo Roller Rouleau	Ø Eje Pin Axe	Longitud eje Pin length Longueur axe	Dimensiones del puente metálico tipo U Plate and “U” attachment dimensions Dimensions plaque et équerres “U”						Carga de rotura Breaking load Charge rupture	Peso por metro Weight per meter Poids par mètre
DIN/ISO	P	B min	D1 max	D max	L max	H	A	C	H5	D4	T2	Q min	q
	mm	mm	mm	mm	mm	mm	mm	mm	mm	mm	mm	KN	Kg/m
08B-U1	12,700	7,75	8,51	4,45	20,00	11,80	14,60	24,20	8,30	4,00	1,60	18,00	1,13
08B-U2	12,700	7,75	8,51	4,45	34,30	11,80	28,40	24,20	8,30	4,00	1,50	32,00	1,96
10B-U1	15,875	9,65	10,16	5,08	23,20	14,70	16,80	30,00	11,30	5,00	1,60	19,00	1,53
10B-U2	15,875	9,65	10,16	5,08	39,70	14,70	33,30	30,00	11,30	5,00	1,50	44,50	2,47
12B-U1	19,050	11,68	12,07	5,72	25,70	16,00	19,60	36,00	13,00	5,00	1,85	29,00	1,90
12B-U2	19,050	11,68	12,07	5,72	45,30	16,00	39,10	36,00	12,00	5,00	1,85	57,80	3,03
16A-U1	25,400	15,75	15,88	7,92	37,20	24,00	27,50	46,00	16,00	7,00	2,42	42,00	3,87
16B-U1	25,400	17,02	15,88	8,28	39,70	21,00	29,05	49,00	15,40	6,00	1,60	58,00	3,73
16B-U2	25,400	17,02	15,88	8,28	71,70	21,00	60,93	49,00	16,20	6,00	1,60	106,00	6,15
20B-U1	31,750	19,56	19,05	10,19	48,00	26,40	36,00	57,00	21,00	8,00	3,50	85,00	6,00
24B-U1	38,100	25,40	25,40	14,63	61,60	33,20	47,00	72,60	28,00	10,00	4,50	160,00	10,88

CADENAS DE RODILLOS DE DOBLE PASO

Double pitch roller chains

Chaînes à rouleaux double pas

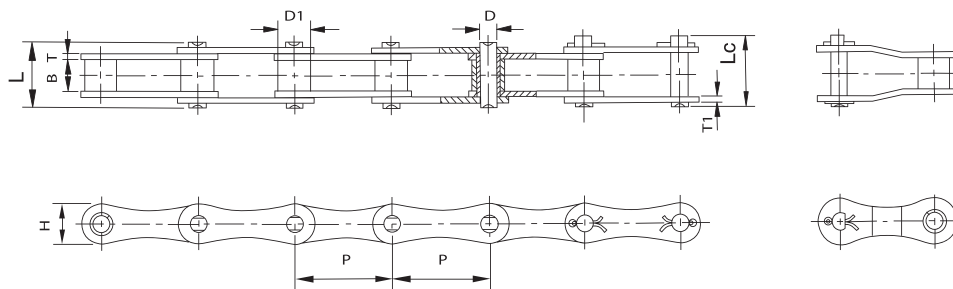

Cadenas de rodillos de doble paso

Double pitch roller chains

Chaînes à rouleaux double pas

Referencia Reference Référence		Paso Pitch Pas	Ancho interior Inner width Largeur intérieure	Ø Rodillo Roller Rouleau	Ø Eje Pin Axe	Longitud eje Pin length Longueur axe		Ancho malla Plate width Largeur plaques	Espesor malla Plate thickness Épaisseur plaques	Carga de rotura Breaking load Charge rupture	Peso por metro Weight per meter Poids par mètre
DIN/ISO	ANSI	P	B min	D1 max	D max	L max	Lc max	H max	T/T1 max	Q min	q
		mm	mm	mm	mm	mm	mm	mm	mm	KN	Kg/m
208A	2040	25,40	7,85	7,95	3,96	16,6	17,8	12,0	1,50	14,1	0,42
208B		25,40	7,75	8,51	4,45	16,7	18,2	11,8	1,60	18,0	0,45
210A	2050	31,75	9,40	10,16	5,08	20,7	22,2	15,0	2,03	22,2	0,73
210B		31,75	9,65	10,16	5,08	19,5	20,9	14,7	1,70	22,4	0,65
212A	2060	38,10	12,57	11,91	5,94	25,9	27,7	18,0	2,42	31,8	1,02
212B		38,10	11,68	12,07	5,72	22,5	25,2	16,0	1,85	29,0	0,76
216A	2080	50,80	15,75	15,88	7,92	32,7	36,5	24,0	3,25	56,7	1,70
216AH	2080H	50,80	15,75	15,88	7,92	36,2	39,4	24,0	4,00	56,7	2,17
216B		50,80	17,02	15,88	8,28	36,1	39,1	21,0	4,15/3,1	60,0	1,75
220A	2100	63,50	18,90	19,05	9,53	40,4	44,7	30,0	4,00	88,5	2,55
220B		63,50	19,56	19,05	10,19	41,3	45,0	26,4	4,5/3,5	95,0	2,62
224A	2120	76,20	25,22	22,23	11,10	50,3	54,3	35,7	4,80	127,0	4,06
224B		76,20	25,40	25,40	14,63	53,4	57,8	33,2	6,0/4,8	160,0	4,70
228B		88,90	30,99	27,94	15,90	65,1	69,5	36,7	7,5/6,0	200,0	6,23
232B		101,60	30,99	29,21	17,81	66,0	71,0	42,0	7,0/6,0	250,0	6,72

CADENAS DE RODILLOS DE DOBLE PASO

Double pitch roller chains

Chaînes à rouleaux double pas



Aleta 90° 1 taladro 1 lado

Attachment 90° 1 hole 1 side

Équerre 90° 1 trou 1 côté

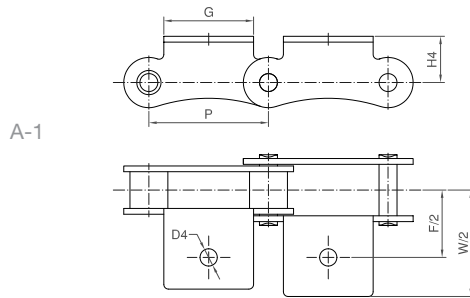

Aleta vertical 1 taladro 1 lado

Straight attachment 1 hole 1 side

Équerre verticale 1 trou 1 côté

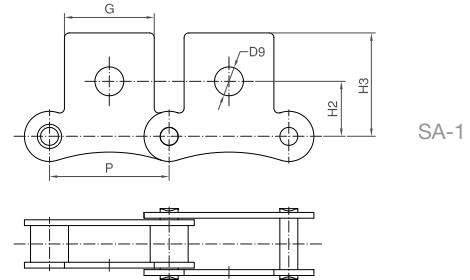

Aleta 90° 1 taladro 2 lados

Attachment 90° 1 hole 2 sides

Équerre 90° 1 trou 2 côtés

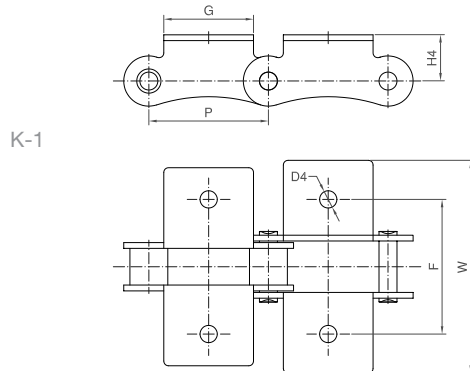

Aleta vertical 1 taladro 2 lados

Straight attachment 1 hole 2 sides

Équerre verticale 1 trou 2 côtés

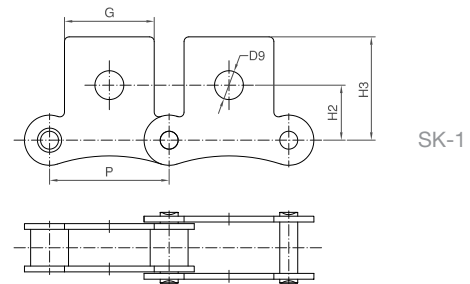

Cadenas de rodillos de doble paso con aletas

Double pitch roller chains with attachments

Chaînes à rouleaux double pas avec équerres

Referencia Reference Référence		P	G	F	W	H4	D4	H2	H3	D9
DIN/ISO	ANSI	mm	mm	mm	mm	mm	mm	mm	mm	mm
208A	2040	25,40	19,1	25,4	39,6	9,1	3,4	11,1	20,5	5,5
210A	2050	31,75	23,8	31,8	49,0	11,1	5,5	14,3	25,0	6,6
212A	2060	38,10	28,6	42,9	67,8	14,7	5,5	17,5	32,9	9,2
216A	2080	50,80	38,1	55,6	87,8	19,1	6,8	22,2	43,5	11,0
220A	2100	63,50	47,6	66,6	107,5	23,4	9,2	28,6	50,4	13,0
224A	2120	76,20	57,2	79,3	127,5	27,8	10,5	33,3	55,5	15,0
208B		25,40	23,2	25,4	39,6	9,1	4,5			
210B		31,75	23,8	31,8	49,0	11,1	5,5			
212B		38,10	35,0	38,1	57,0	14,7	6,6			
216B		50,80	44,0	50,8	84,0	19,1	6,6			
220B		63,50	52,0	63,5	104,0	23,4	8,4			
224B		76,20	60,0	76,2	120,0	27,8	10,5			

CADENAS DE RODILLOS DE DOBLE PASO

Double pitch roller chains

Chaînes à rouleaux double pas



Tipo rodillo pequeño

Small roller type

Type petit rouleau

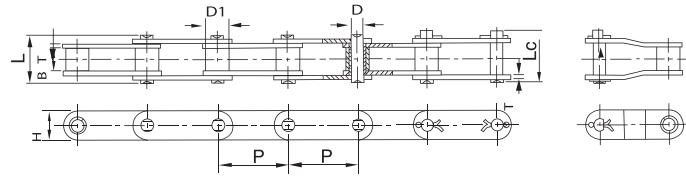

Tipo rodillo grande

Big roller type

Type grand rouleau

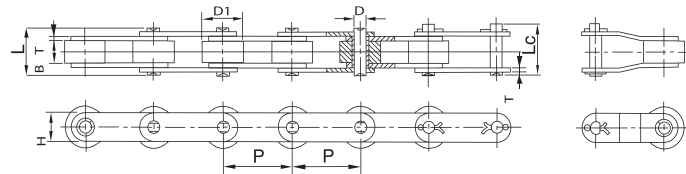

Cadenas de rodillos de doble paso con mallas rectas - Serie A

Double pitch roller chains with straight plates - A series

Chaînes à rouleaux double pas avec équerres droites - Série A

Referencia Reference Référence	Paso Pitch Pas	Ancho interior Inner width Largeur intérieure	Ø Rodillo Roller Rouleau	Ø Eje Pin Axe	Longitud eje Pin length Longueur axe	Ancho malla Plate width Largeur plaques	Espesor malla Plate thickness Épaisseur plaques	Carga de rotura Breaking load Charge rupture	Peso por metro Weight per meter Poids par mètre		
DIN/ISO	ASA	P	B min	D1 max	D max	L max	Lc max	H max	T max	Q min	q
		mm	mm	mm	mm	mm	mm	mm	mm	KN	Kg/m
C208A	C2040	25,40	7,85	7,95	3,96	16,6	17,8	12,0	1,50	14,1	0,50
C208AL	C2042			15,88							0,84
C208AH	C2040H	25,40	7,85	7,95	3,96	18,8	19,9	12,0	2,03	14,1	0,65
C208AHL	C2042H			15,88							0,99
C210A	C2050	31,75	9,40	10,16	5,08	20,7	22,2	15,0	2,03	22,2	0,78
C210AL	C2052			19,05							1,27
C210AH	C2050H	31,75	9,40	10,16	5,08	22,1	23,5	15,0	2,42	22,2	0,96
C210AHL	C2052H			19,05							1,41
C212A	C2060	38,10	12,57	11,91	5,94	25,9	27,7	18,0	2,42	31,8	1,12
C212AL	C2062			22,23							1,61
C212AH	C2060H	38,10	12,57	11,91	5,94	29,2	31,6	18,0	3,25	31,8	1,44
C212AHL	C2062H			22,23							2,07
C216A	C2080	50,80	15,75	15,88	7,92	32,7	36,5	24,0	3,25	56,7	2,08
C216AL	C2082			28,58							3,12
C216AH	C2080H	50,80	15,75	15,88	7,92	36,2	39,4	24,0	4,00	56,7	2,54
C216AHL	C2082H			28,58							3,58
C220A	C2100	63,50	18,90	19,05	9,53	40,4	44,7	30,0	4,00	88,5	3,01
C220AL	C2102			39,67							4,83
C220AH	C2100H	63,50	18,90	19,05	9,53	43,6	46,9	30,0	4,80	88,5	3,56
C220AHL	C2102H			39,67							5,38
C224A	C2120	76,20	25,22	22,23	11,10	50,3	54,3	35,7	4,80	127,0	4,66
C224AL	C2122			44,45							7,66
C224AH	C2120H	76,20	25,22	22,23	11,10	53,5	57,5	35,7	5,60	127,0	5,26
C224AHL	C2122H			44,45							8,26
C232A	C2160	101,60	31,75	28,58	14,27	64,8	69,6	47,8	6,40	226,8	8,15
C232AL	C2162			57,15							13,00
C232AH	C2160H	101,60	31,75	28,58	14,27	68,2	73,0	47,8	7,20	226,8	9,06
C232AHL	C2162H			57,15							12,77

CADENAS DE RODILLOS DE DOBLE PASO

Double pitch roller chains

Chaînes à rouleaux double pas

Aleta 90° 1 taladro 1 lado

Attachment 90° 1 hole 1 side

Équerre 90° 1 trou 1 côté

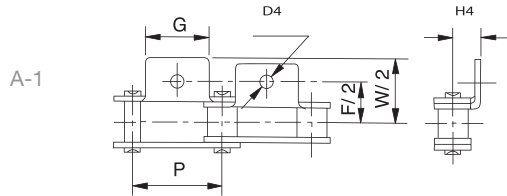

Aleta 90° 1 taladro 2 lados

Attachment 90° 1 hole 2 sides

Équerre 90° 1 trou 2 côtés

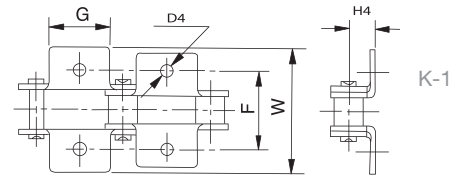

Aleta 90° 2 taladros 1 lado

Attachment 90° 2 holes 1 side

Équerre 90° 2 trous 1 côté

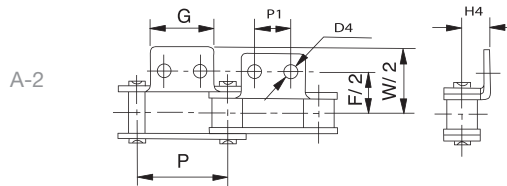

Aleta 90° 2 taladros 2 lados

Attachment 90° 2 holes 2 sides

Équerre 90° 2 trous 2 côtés

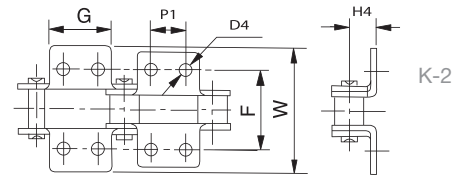

Cadenas de rodillos de doble paso con aletas 90° - Serie A

Double pitch roller chains with attachment 90° - A series

Chaînes à rouleaux double pas avec équerres 90° - Série A

Referencia Reference Référence		P	G	P1	F	W	H4	D4
DIN/ISO	ANSI	mm	mm	mm	mm	mm	mm	mm
C208A	C2040	25,40	19,1	9,5	25,4	39,6	9,1	3,4
C208AL	C2042							
C210A	C2050	31,75	23,8	11,9	31,8	49,0	11,1	5,5
C210AL	C2052							
C212A	C2060	38,10	28,6	14,3	42,9	67,8	14,7	5,5
C212AL	C2062							
C212AH	C2060H	38,10	28,6	14,3	42,9	67,8	14,7	5,5
C212AHL	C2062H							
C216A	C2080	50,80	38,1	19,1	55,6	87,8	19,1	6,8
C216AL	C2082							
C216AH	C2080H	50,80	38,1	19,1	55,6	87,8	19,1	6,8
C216AHL	C2082H							
C220A	C2100	63,50	47,6	23,8	66,6	107,5	23,4	9,2
C220AL	C2102							
C220AH	C2100H	63,50	47,6	23,8	66,6	107,5	23,4	9,2
C220AHL	C2102H							
C224A	C2120	76,20	57,2	28,6	79,3	121,4	27,8	11,0
C224AL	C2122							
C224AH	C2120H	76,20	57,2	28,6	79,3	121,4	27,8	11,0
C224AHL	C2122H							
C232A	C2160	101,60	76,2	38,1	104,7	151,6	36,5	13,1
C232AL	C2162							
C232AH	C2160H	101,60	76,2	38,1	104,7	151,6	36,5	13,1
C232AHL	C2162H							

CADENAS DE RODILLOS DE DOBLE PASO

Double pitch roller chains

Chaînes à rouleaux double pas

Aleta vertical 1 taladro 1 lado

Straight attachment 1 hole 1 side

Équerre verticale 1 trou 1 côté

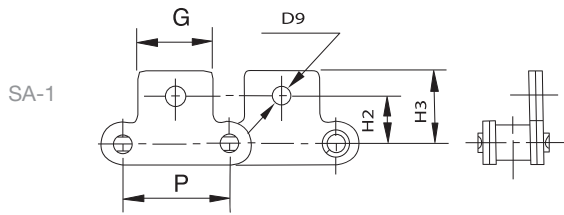

Aleta vertical 1 taladro 2 lados

Straight attachment 1 hole 2 sides

Équerre verticale 1 trou 2 côtés

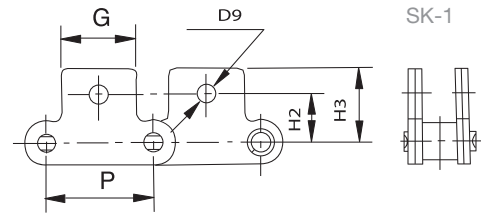

Aleta vertical 2 taladros 1 lado

Straight attachment 2 holes 1 side

Équerre verticale 2 trous 1 côté

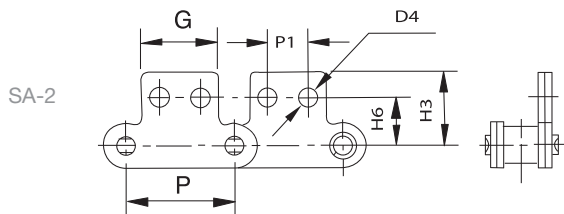

Aleta vertical 2 taladros 2 lados

Straight attachment 2 holes 2 sides

Équerre verticale 2 trous 2 côtés

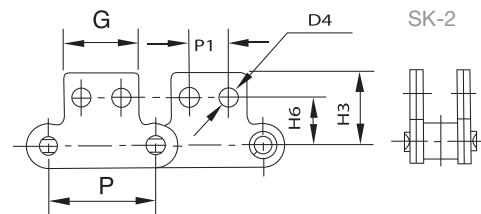

Cadenas de rodillos de doble paso con aletas verticales - Serie A

Double pitch roller chains with vertical attachments - A Series

Chaînes à rouleaux double pas avec équerres verticales - Série A

Referencia Reference Référence		P	G	P1	H2	H6	H3	D4	D9
DIN/ISO	ANSI	mm	mm	mm	mm	mm	mm	mm	mm
C208A	C2040	25,40	19,1	9,5	11,1	13,5	20,5	3,4	5,5
C208AL	C2042								
C210A	C2050	31,75	23,8	11,9	14,3	15,9	25,0	5,5	6,6
C210AL	C2052								
C212A	C2060	38,10	28,6	14,3	17,5	19,1	32,9	5,5	9,2
C212AL	C2062								
C212AH	C2060H	38,10	28,6	14,3	17,5	19,1	32,9	5,5	9,2
C212AHL	C2062H								
C216A	C2080	50,80	38,1	19,1	22,2	25,4	43,5	6,6	11,0
C216AL	C2082								
C216AH	C2080H	50,80	38,1	19,1	22,2	25,4	43,5	6,6	11,0
C216AHL	C2082H								
C220A	C2100	63,50	47,6	23,8	28,6	31,8	50,4	8,4	13,0
C220AL	C2102								
C220AH	C2100H	63,50	47,6	23,8	28,6	31,8	50,4	8,4	13,0
C220AHL	C2102H								

CADENAS DE RODILLOS DE DOBLE PASO

Double pitch roller chains

Chaînes à rouleaux double pas

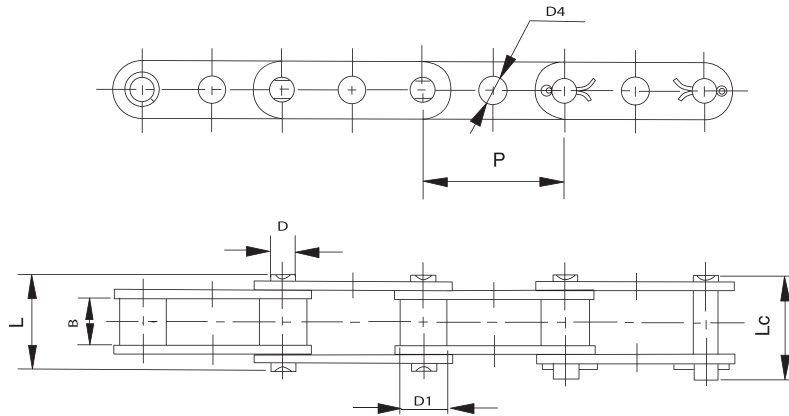

Cadenas de rodillo de doble paso con taladro - Serie A

Double pitch roller chains straight plates with hole - A series

Chaînes à rouleaux double pas avec trou - Série A

Referencia Reference Référence		P	B min	D1 max	D max	D4	L max	Lc max
DIN/ISO	ANSI	mm	mm	mm	mm	mm	mm	mm
C208A	C2040	25,40	7,85	7,95	3,96	4,1	16,6	18,8
C208AL	C2042			15,88				
C210A	C2050	31,75	9,40	10,16	5,08	7,1	20,7	23,3
C210AL	C2052			19,05				
C212A	C2060	38,10	12,57	11,91	5,94	8,3	25,9	28,3
C212AL	C2062			22,23				
C212AH	C2060H	38,10	12,57	11,91	5,94	8,3	29,2	31,6
C212AHL	C2062H			22,23				
C216A	C2080	50,80	15,75	15,88	7,92	8,3	32,7	36,5
C216AL	C2082			28,58				
C216AH	C2080H	50,80	15,75	15,88	7,92	8,3	36,2	39,4
C216AHL	C2082H			28,58				
C220A	C2100	63,50	18,90	19,05	9,53	10,1	40,4	44,7
C220AL	C2102			39,67				
C220AH	C2100H	63,50	18,90	19,05	9,53	10,1	43,6	46,9
C220AHL	C2102H			39,67				

CADENAS DE EJE HUECO

Hollow pin chains
Chânes axe creux

Tipo A casquillo fijo

Type A fixed bush
Type A douilles

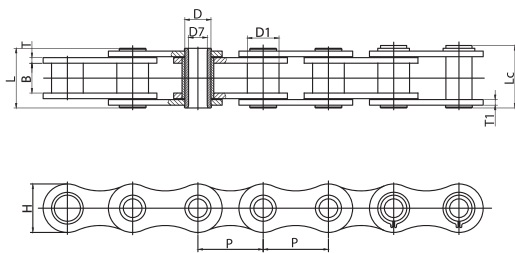

Tipo B rodillos

Type B roller
Type B rouleaux

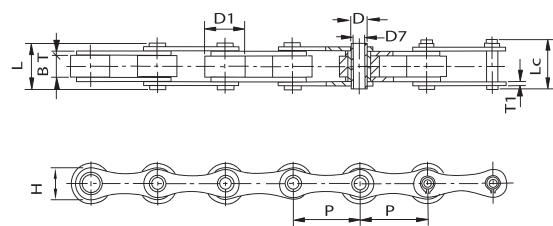

Cadenas de eje hueco

Hollow pin chain
Chânes axe creux

Referencia Reference Référence	Paso Pitch Pas	Ancho interior Inner width Largeur intérieure	Ø Rodillo Roller Rouleau	Ø Eje Pin Axe		Longitud eje Pin length Longueur axe		Ancho malla Plate width Largeur plaques	Espesor malla Plate thickness Épaisseur plaques	Carga de rotura Breaking load Charge rupture	Peso por metro Weight per meter Poids par mètre	Tipo Type Type
	P	B min	D1 max	D max	D7 min	L max	Lc max	H max	T/T1 max	Q min	q	
	mm	mm	mm	mm	mm	mm	mm	mm	mm	KN	Kg/m	
08BHP	12,7	7,75	8,51	6,55	4,50	16,4	17,6	11,80	1,60/1,30	11,10	0,56	A
10BHP	15,875	9,65	10,16	7,02	5,13	19,5	20,5	14,7	1,70	10,00	0,86	A
12BHP	19,050	11,68	12,07	8,09	6,00	22,7	23,9	16,1	1,85	14,00	0,82	A
16BHP	25,4	17,02	15,88	11,50	8,20	35,3	37,0	23,2	4,0 / 3,1	49,00	2,26	A
40HP	12,7	7,85	7,95	5,63	4,00	16,5	17,6	12,0	1,50	11,00	0,54	A
50HP	15,875	9,40	10,16	7,03	5,13	20,7	21,9	15,09	2,03	20,00	0,91	A
60HP	19,05	12,70	11,91	8,31	6,00	25,8	26,8	18,0	2,42	24,00	1,29	A
80HP	25,4	15,75	15,88	11,40	8,05	32,5	33,8	24,0	3,25	50,00	2,26	A
70254HG000***	25,4	11	20	12	8,2	27	29	24	3	38,4		B
70254HTS04	25,4	17,02	15,88	6,05	4,2	28	30	14	2	19,2		B
70350HT000**	35	16	20	14	10,2	32	34	26	3	43		B
70381HG000***	38,1	12,7	25,4*	12	8,2	27	29	21	2,5	24		B
70417HG000***	41,75	20,5	17	11	8,2	36	38	22	3	38,4		B
70500HG001***	50	10	30*	11,5	8,2	27,4	28,5	26	3	51,5		B
70500HG008***	50	10	30	11,5	8,2	27,4	28,5	26	3	51,5		B
70508HT003**	50,8	10	30	11,5	8,2	27,4	28,5	26	3	51,5		B
70508HT004**	50,8	10	30*	11,5	8,2	27,4	28,5	26	3	51,5		B
71000HG005***	100	10	30	11,5	8,2	27,4	28,5	26	3	51,5		B

* Rodillo delrin / POM roller / Rouleau POM

** Disponible zincada / Available zinc plated / Disponible Zinguée

*** Zincada / Zinc plated / Zinguée

CADENAS DE EJE HUECO

Hollow pin chains
Chaînes axe creux

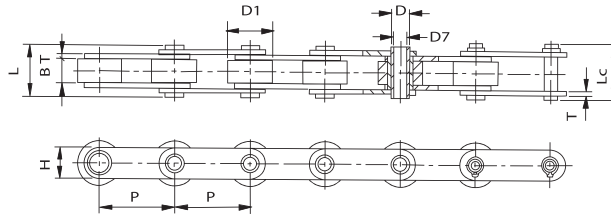

Cadenas de doble paso de eje hueco

Double pitch chains with hollow pin
Chaîne double pas avec axe creux

Referencia Reference Référence	Paso Pitch Pas	Ancho interior Inner width Largeur intérieure	Ø Rodillo Roller Rouleau	Ø Eje Pin Axe	Longitud eje Pin length Longueur axe		Ancho malla Plate width Largeur plaques	Espesor malla Plate thickness Épaisseur plaques	Carga de rotura Breaking load Charge rupture	Peso por metro Weight per meter Poids par mètre	
	P	B min	D1 max	D max	D7 min	L max	Lc max	H max	T max	Q min	q
	mm	mm	mm	mm	mm	mm	mm	mm	mm	KN	Kg/m
C2040HP***	25,400	7,85	7,95	5,63	4,00	16,50	17,60	12	1,50	11,00	0,46
C2050HP***	31,750	9,40	10,16	7,22	5,12	20,50	21,80	15	2,03	20,40	0,76
C2060HP***	38,100	12,70	11,91	8,31	6,00	25,80	26,80	17	2,42	24,00	1,02
C2080HP***	50,800	15,75	15,88	11,40	8,05	32,50	33,80	24	3,25	50,00	1,81
C2042HP	25,40	7,85	15,88	5,63	4,00	16,5	17,6	12	1,50	11,0	0,78
C2052HP	31,75	9,53	19,05	7,22	5,12	20,5	21,8	15	2,03	20,4	1,25
C2062HP	38,10	12,70	22,23	8,31	6,00	25,8	26,8	17	2,42	24,0	1,72
C2082HP	50,80	15,75	28,58	11,40	8,05	32,4	33,8	24	3,25	50,0	2,82
C2042H-HP	25,40	7,85	15,88	5,63	4,00	18,8	19,9	12	2,03	11,0	0,95
C2052H-HP	31,75	9,53	19,05	7,22	5,12	22,1	23,4	15	2,42	20,4	1,44
C2062H-HP	38,10	12,70	22,23	8,31	6,00	29,2	30,2	17	3,25	24,0	1,99
C2082H-HP	50,80	15,75	28,58	11,40	8,05	35,7	37	24	4,00	50,0	3,26
70500HT001	50	11,5	25	9	6,2	25	27	20	2,5	36	
70500HT003***	50	15	18	14	10,2	36	38	26	4	57,6	
70500HT009***	50	22	17	12	8	41	43	25	3	43,2	
70500HG000**	50	15	31	14	10,2	36	38	25	4	51,2	
70500HG004**	50	15	31*	14	10,2	31	33	25	3	38,4	
70500HG007**	50	15	31	14	10,2	31	33	25	3	38,4	
70630HG000**	63	18	30	14	10,2	35	37	25	3	33,6	
70700HG000****	70	14	25	16	12,2	35,5	37,5	30	4	64	
70700HG001**	70	15	30	16	12,2	36,5	38,5	35	4	84	
70750HT000	75	15	31	14	10,2	36,5	38,5	25	4	51,2	
70750HT001	75	15,5	28	14	8,5	37	39	35	4	102,4	
70750HT003***	75	22	20	14	10,2	41	43	30	3	57,6	
70800HG002**	80	24	42/50	16	10,2	45,5	47,5	30	4	64	
71000HG001**	100	32	30	18	14,2	62	64	40	6	96,5	
71000HG004**	100	15	30	16	12,2	36,5	38,5	35	4	96	
71000HT000	100	15	31	14	10,2	36,5	38,5	25	4	51,2	
71000HT005	100	22	40	18	12,2	45	47	35	4	83,2	
71000HT014	100	25	40	25	20,2	52	54	50	5	160	
71025HT000	102,5	15	30	17	8,5	37	39	40	4	115,2	
71050HT000	105	15,5	30	20	14,5	38	40	40	4	96	

* Rodillo delrin / POM roller / Rouleau POM

** Zincada / Zinc plated / Zinguée

*** Casquillo fijo / Fixed bush chain / Chaîne à douille

**** Niquelada / Nickel plated / Nickelée

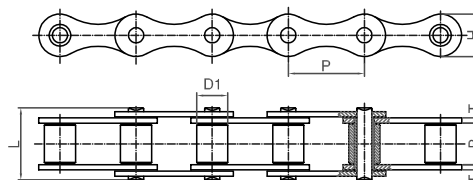

Referencia Reference Référence	Paso Pitch Pas	Ancho interior Inner width Largeur intérieure	Ø Rodillo Roller Rouleau	Ø Eje Pin Axe	Longitud eje Pin length Longueur axe	Ancho malla Plate width Largeur plaques	Espesor malla Plate thickness Épaisseur plaques	Carga de rotura Breaking load Charge rupture	Peso por metro Weight per meter Poids par mètre
	P	B min	D1 max	D max	L max	H	T	Q	q
	mm	mm	mm	mm	mm	mm	mm	KN	Kg/m
S-32	29,21	15,88	11,43	4,45	26,7	13,2	1,8	15,00	0,86
S-42	34,93	19,05	14,27	7,00	34,3	19,8	2,8	27,00	1,60
S-45	41,40	22,23	15,24	5,72	37,7	17,3	2,8	18,00	1,66
S-52	38,10	22,23	15,24	5,72	37,7	17,3	2,5	18,00	1,68
S-55	41,40	22,23	17,78	5,72	37,7	17,3	2,8	18,00	1,80
S-62	41,91	25,40	19,05	5,72	40,3	17,3	2,5	26,70	1,87
S-77	58,34	22,23	18,26	8,90	43,2	26,2	4,0	45,00	2,66
S-88	66,27	28,58	22,86	8,90	49,8	26,2	4,0	45,00	3,25
C-550	41,40	19,81	16,87	7,19	35,0	19,3	2,8	39,10	1,94
C-620	42,01	24,51	17,91	7,19	41,8	20,2	3,25	39,10	2,35

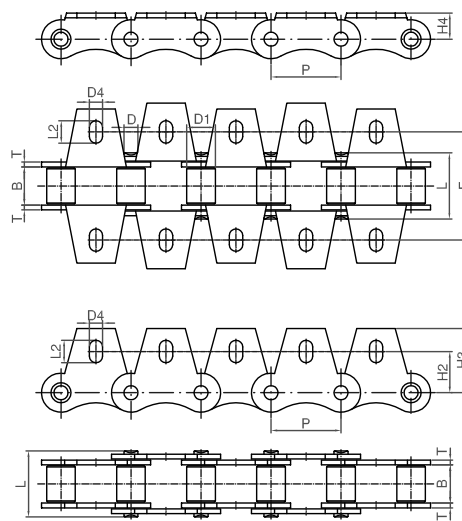

Cadenas agrícolas con aletas

Agricultural chains with attachments
Chaînes agriculture avec équerres

Referencia Reference Référence	Paso Pitch Pas	Ancho interior Inner width Largeur intérieure	Ø Rodillo Roller Rouleau	Ø Eje Pin Axe	Longitud eje Pin length Longueur axe	Altura aleta Attachment height Hauteur équerre	Ancho taladro Hole width Largeur trou	Longitud taladro Hole Length Longueur Trou	Distancia entre taladros Distance between holes Distance entre trous	Altura taladro Hole height Hauteur trou	Altura de aleta Attachment height Hauteur équerre	Carga de rotura Breaking load Charge rupture
ISO	P	B min	D1 max	D max	L max	H4	D4	L2	F	H2	H3	Q
	mm	mm	mm	mm	mm	mm	mm	mm	mm	mm	mm	Kn
S-32	29,21	15,88	11,43	4,45	26,7	8,6	5,3	6,9	42,9	17,3	26,2	15,00
S-42	34,93	19,05	14,27	7,00	34,3	14	8,3	11,5	54,0	23,6	34,3	27,00
S-45	41,40	22,23	15,24	5,72	37,7	11,4	8,5	11,7	54,0	19,8	30,2	18,00
S-52	38,10	22,23	15,24	5,72	37,7	11,4	8,3	9,9	58,8	22,1	31,8	18,00
S-55	41,40	22,23	17,78	5,72	37,7	11,4	8,5	11,7	54,0	19,8	30,2	18,00
S-62	41,91	25,40	19,05	5,72	40,3	11,4	8,3	14,7	66,8	24,6	38,6	26,70
S-77	58,34	22,23	18,26	8,90	43,2	20,8	8,3	11,5	76,2	36,3	50,0	45,00
S-88	66,27	28,58	22,86	8,90	49,8	20,8	8,3	9,9	97,0	43,7	55,6	45,00

CADENAS DE RODILLOS DE ACERO INOXIDABLE

Stainless steel roller chains

Chaînes à rouleaux acier inox

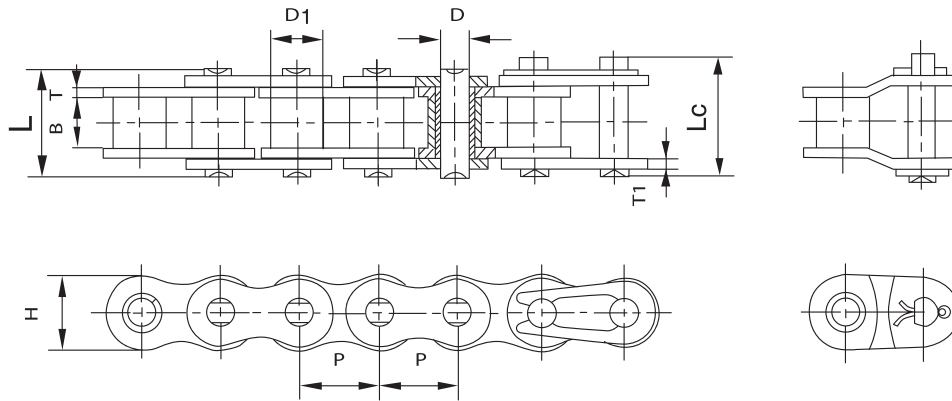

Referencia Reference Référence	Paso Pitch Pas	Ancho interior Inner width Largeur intérieure	Ø Rodillo Roller Rouleau	Ø Eje Pin Axe	Longitud eje Pin length Longueur axe		Ancho malla Plate width Largeur plaques	Espesor malla Plate thickness Épaisseur plaques	Carga de rotura Breaking load Charge rupture	Peso por metro Weight per meter Poids par mètre
DIN/ISO	P	B min	D1 max	D max	L max	Lc max	H max	T/T1 max	Q min	q
	mm	mm	mm	mm	mm	mm	mm	mm	KN	Kg/m
25SS*	6,350	3,18	3,30	2,31	7,9	8,4	6,00	0,8	2,5	0,15
35SS*	9,525	4,77	5,08	3,58	12,4	13,17	9,00	1,30	5,5	0,33
40SS	12,700	7,85	7,95	3,96	16,6	17,8	12,00	1,50	9,6	0,63
50SS	15,875	9,40	10,16	5,08	20,7	22,2	15,09	2,03	15,2	1,03
60SS	19,050	12,57	11,91	5,94	25,9	27,7	18,00	2,42	21,7	1,51
80SS	25,400	15,75	15,88	7,92	32,7	35,0	24,00	3,25	38,9	2,62
100SS	31,750	18,90	19,05	9,53	40,4	44,7	30,00	4,00	60,0	3,94
120SS	38,100	25,22	22,23	11,10	50,3	54,3	35,70	4,8	72,5	5,72
04BSS	6,000	2,80	4,00	1,85	6,80	7,8	5,00	0,60	2,0	0,11
05BSS**	8,000	3,00	5,00	2,31	8,20	8,9	7,10	0,80	3,5	0,20
06BSS**	9,525	5,72	6,35	3,28	13,15	14,1	8,20	1,30	6,2	0,41
08BSS	12,700	7,75	8,51	4,45	16,7	18,2	11,80	1,60	12,0	0,70
10BSS	15,875	9,65	10,16	5,08	19,5	20,9	14,70	1,70	14,5	0,94
12BSS	19,050	11,68	12,07	5,72	22,5	24,2	16,00	1,85	18,5	1,16
16BSS	25,400	17,02	15,88	8,28	36,1	37,4	21,00	4,15/3,1	40,0	2,73
20BSS	31,750	19,56	19,05	10,19	41,3	45,0	26,40	4,5/3,5	59,0	3,73
24BSS	38,100	25,40	25,40	14,63	53,4	57,8	33,20	6,0/4,8	104,0	7,20
32BSS	50,8	30,99	29,21	17,81	66,0	71,0	42,00	7,0/6,0	150,0	10,22

* Casquillo fijo / Fixed bush chain / Chaîne à douille

** Malla recta / Straight plates / Plaques droites

CADENAS DE ACERO INOXIDABLE DE DOBLE PASO

Stainless steel double pitch chains

Chaînes à rouleaux acier inox double pas



Tipo de rodillo pequeño
Small roller type
Type petit rouleau

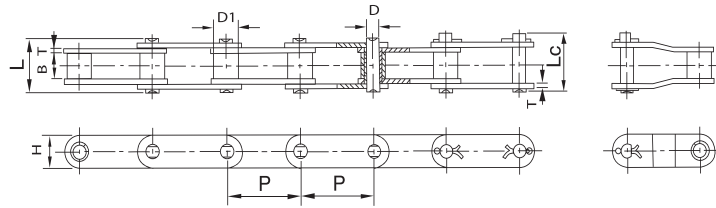

Tipo de rodillo grande
Big roller type
Type grand rouleau

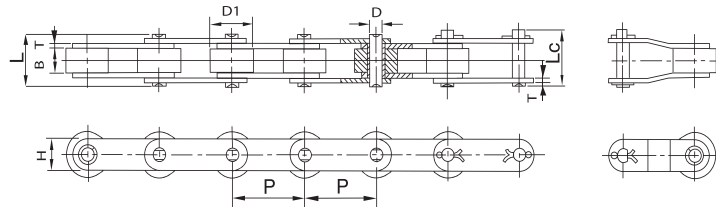

Referencia Reference Référence	Paso Pitch Pas	Ancho interior Inner width Largeur intérieur	Ø Rodillo Roller Rouleau	Ø Eje Pin Axe	Longitud eje Pin length Longueur axe		Ancho malla Plate width Largeur plaques	Espesor malla Plate thickness Épaisseur plaques	Carga de rotura Breaking load Charge rupture	Peso por metro Weight per meter Poids par mètre
ASA	P	B min	D1 max	D max	L max	Lc max	H max	T max	Q min	q
	mm	mm	mm	mm	mm	mm	mm	mm	KN	Kg/m
C2040SS	25,40	7,85	7,95	3,96	16,6	17,8	12,0	1,50	9,6	0,51
C2042SS			15,88							0,85
C2040HSS	25,40	7,85	7,95	3,96	18,8	19,9	12,0	2,03	9,6	0,66
C2042HSS			15,88							0,99
C2050SS	31,75	9,40	10,16	5,08	20,7	22,2	15,0	2,03	15,2	0,79
C2052SS			19,05							1,29
C2050HSS	31,75	9,40	10,16	5,08	22,1	23,5	15,0	2,42	15,2	0,97
C2052HSS			19,05							1,42
C2060SS	38,10	12,57	11,91	5,94	25,9	27,7	18,0	2,42	21,7	1,13
C2062SS			22,23							1,63
C2060HSS	38,10	12,57	11,91	5,94	29,2	31,6	18,0	3,25	21,7	1,46
C2062HSS			22,23							2,10
C2080SS	50,80	15,75	15,88	7,92	32,7	36,5	24,0	3,25	38,9	2,11
C2082SS			28,58							3,16
C2080HSS	50,80	15,75	15,88	7,92	36,2	39,4	24,0	4,00	38,9	2,57
C2082HSS			28,58							3,63
C2100SS	63,50	18,90	19,05	9,53	40,4	44,7	30,0	4,00	60,0	3,05
C2102SS			39,67							4,89
C2100HSS	63,50	18,90	19,05	9,53	43,6	46,9	30,0	4,80	60,0	3,61
C2102HSS			39,67							5,45

CADENAS DE ACERO INOXIDABLE DE EJE HUECO

Stainless steel hollow pin chains

Chaînes acier inox avec axe creux



Tipo A/A type

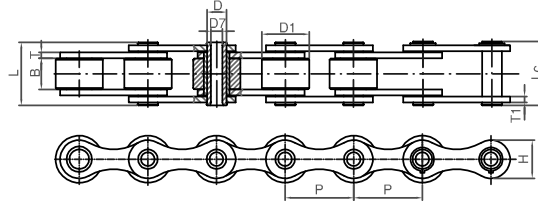

Tipo B/B type

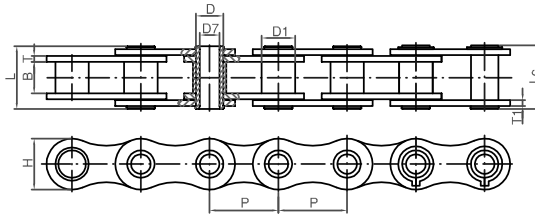

Tipo C/C type

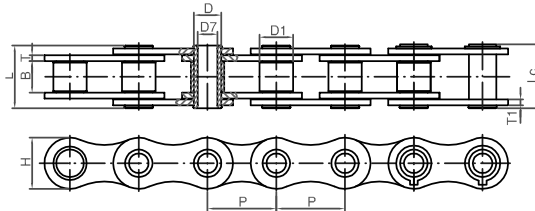

Cadenas de eje hueco de acero inoxidable

Stainless steel hollow pin chains

Chaînes avec axe creux acier inox

Referencia Reference Référence	Paso Pitch Pas	Ancho interior Inner width Largeur intérieur	Ø Rodillo Roller Rouleau	Ø Eje Pin Axe		Longitud eje Pin length Longueur axe		Ancho malla Plate width Largeur plaques	Espesor malla Plate thickness Épaisseur plaques	Carga de rotura Breaking load Charge rupture	Peso por metro Weight per meter Poids par mètre	Tipo Type Type
	P	B min	D1 max	D max	D7 min	L max	Lc max	H max	T/T1 max	Q min	q	
	mm	mm	mm	mm	mm	mm	mm	mm	mm	KN	Kg/m	
40HPSS	12,700	7,85	7,95	5,63	4,00	16,50	17,60	12,00	1,50	7,70	0,55	B
50HPSS	15,875	9,40	10,16	7,03	5,13	20,70	21,90	15,09	2,03	14,00	0,92	B
60HPSS	19,050	12,70	11,91	8,31	6,00	25,80	26,80	18,00	2,42	16,80	1,31	B/C
80HPSS	25,400	15,75	15,88	11,40	8,05	32,50	33,80	24,00	3,25	35,00	2,29	B
08BHPSS	12,700	7,75	8,51	6,38	4,50	16,60	17,75	11,80	1,60	5,50	0,57	B/C
10BHPSS	15,875	9,65	10,16	7,02	5,13	19,50	20,50	14,70	1,70	11,90	0,86	B/C
12BHPSS	19,050	11,68	12,07	8,09	6,00	22,70	23,90	16,10	1,85	15,30	0,82	B/C
16BHPSS	25,400	17,02	15,88	11,50	8,20	35,30	37,00	23,20	4,00/3,10	36,70	2,26	B/C
70254HIS01	25,400	17,02	15,88	8,00	6,00	33,00	35,00	21,00	3,00	36,30		A
70254HIS04	25,400	8,00	16,00	6,00	4,20	19,20	20,70	12,00	2,00	8,80		A
70317HI002	31,750	11,00	20,00	7,00	4,20	23,00	24,50	16,50	2,00	16,50		A
70317HI004	31,750	19,56	19,05	10,20	6,20	40,00	42,00	26,00	4,00	55,00		A
70350HI000	35,000	16,00	20,00	14,00	10,20	32,00	34,00	26,00	3,00	29,70		A
70417HI000	41,750	20,50	17,00	11,00	8,20	36,00	38,00	22,00	3,00	26,40		A
70508HI000*	50,800	10,00	30,00	11,50	8,20	26,50	28,50	26,00	3,00	46,20		A

* Disponible con rodillo delrin / Available with POM roller / Disponible avec rouleaux POM

CADENAS DE ACERO INOXIDABLE DE DOBLE PASO DE EJE HUECO

Stainless steel double pitch hollow pin chains

Chaînes acier inox à double pas avec axe creux

1

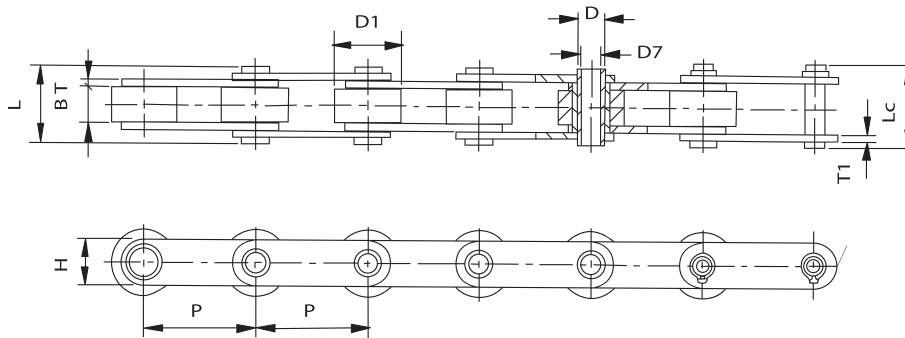

Cadenas de mallas rectas con ejes huecos de acero inoxidable

Stainless steel chains with straight plates and hollow pin

Chaînes avec double pas axe creux acier inox

Referencia Reference Référence	Paso Pitch Pas	Ancho interior Inner width Largeur intérieure	Ø Rodillo Roller Rouleau	Ø Eje Pin Axe		Longitud eje Pin length Longueur axe		Ancho malla Plate width Largeur plaques	Espesor malla Plate thickness Épaisseur plaques	Carga de rotura Breaking load Charge rupture	Peso por metro Weight per meter Poids par mètre
	P	B min	D1 max	D max	D7 min	L max	Lc max	H max	T/T1 max	Q min	q
	mm	mm	mm	mm	mm	mm	mm	mm	mm	KN	Kg/m
C2040HPSS**	25,40	7,85	7,95	5,63	4,00	16,50	17,60	12	1,50	7,70	0,47
C2050HPSS**	31,75	9,40	10,16	7,22	5,12	20,50	21,80	15	2,03	14,30	0,77
C2060HPSS**	38,10	12,70	11,91	8,31	6,00	25,80	26,80	17	2,42	16,80	1,03
C2080HPSS**	50,80	15,75	15,88	11,40	8,05	32,50	33,80	24	3,25	35,00	1,83
C2042HPSS	25,40	7,85	15,88	5,63	4,00	16,50	17,60	12	1,50	7,700	0,79
C2052HPSS	31,75	9,53	19,05	7,22	5,12	20,50	21,80	15	2,03	14,30	1,27
C2062HPSS	38,10	12,70	22,23	8,31	6,00	25,80	26,80	17	2,42	16,80	1,74
C2082HPSS	50,80	15,75	28,58	11,40	8,05	32,40	33,80	24	3,25	35,00	2,86
C2042H-HPSS	25,40	7,85	15,88	5,63	4,00	18,80	19,90	12	2,03	7,70	0,96
C2052H-HPSS	31,75	9,53	19,05	7,22	5,12	22,10	23,40	15	2,42	14,30	1,46
C2062H-HPSS	38,10	12,70	22,23	8,31	6,00	29,20	30,20	17	3,25	16,80	2,02
C2082H-HPSS	50,80	15,75	28,58	11,40	8,05	36,20	37,60	24	4,00	35,00	3,30
70254HIS06	25,40	9,53	10,16	7,20	5,10	20,00	21,50	16	2,00	13,20	
70413HI000*	41,30	14,00	30,00	12,00	10,20	30,50	32,00	24	3,00	29,70	
70500HI000	50,00	15,00	31,00	14,00	10,20	36,00	38,00	25	4,00	35,20	
70500HI002	50,00	11,50	25,00	9,00	6,20	25,00	27,00	20	2,50	24,70	
70800HI000	80,00	24'00	42'50	16,00	10,20	45,50	47,50	30	4,00	44,00	
71000HI002	100,00	21'00	52,00	18,00	14,20	45,00	47,00	40	5,00/4,00	96,80	

* Rodillo Delrin / POM roller / Rouleau POM

** Casquillo fijo / Fixed bush chain / Douille fixe