



POLEAS

PULLEYS

POULIES

Poleas trapeciales

V-belt pulleys / *Poulies trapézoïdales*

130

Poleas trapeciales para taper

V-belt taper bored pulleys

Poulies trapézoïdales pour moyeu amovible

136

Poleas dentadas

Timing belt pulleys / *Poulies dentées*

145

Poleas dentadas para taper

Taper bored timing belt pulleys

Poulies dentées pour moyeu amovible

154

Poleas dentadas HTD

HTD timing belt pulleys / *Poulies dentées HTD*

161

Poleas dentadas HTD para taper

HTD taper bored timing belt pulleys

Poulies dentées HTD pour moyeu amovible

175

Poleas dentadas serie "T"

"T" timing belt pulleys

Poulies dentées série "T"

185

Poleas dentadas serie "AT"

"AT" timing belt pulleys

Poulies dentées série "AT"

194

POLEAS TRAPECIALES

V-belt pulleys

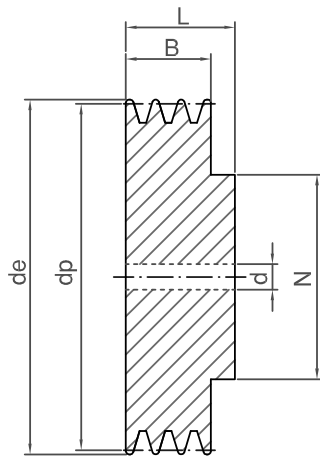
Poulies trapézoïdales

1

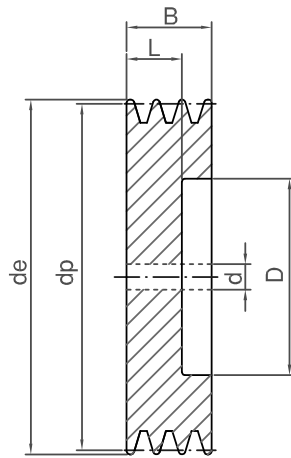

2

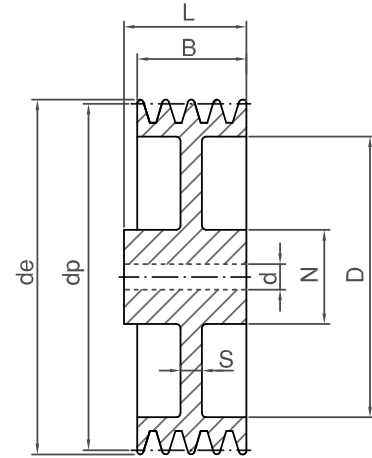

3

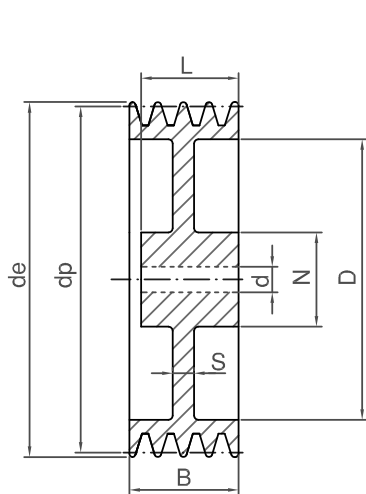

4

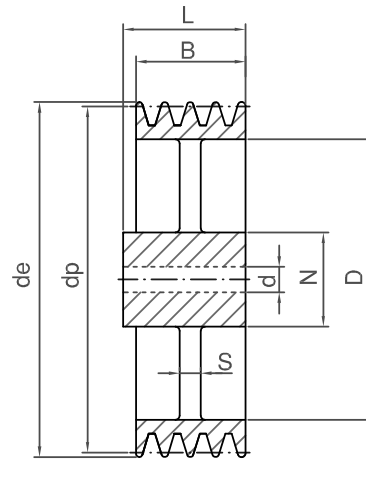

5

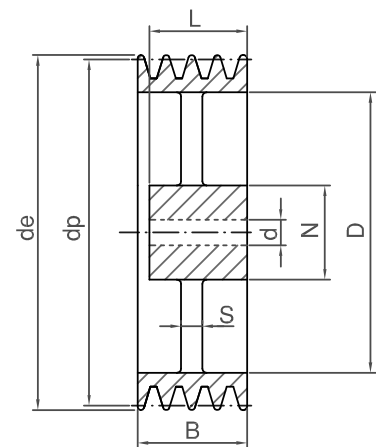

6

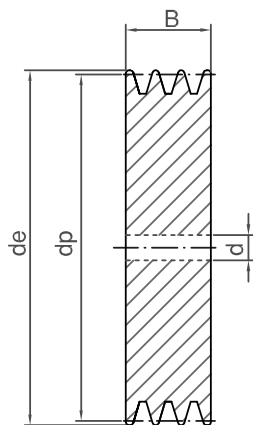

7

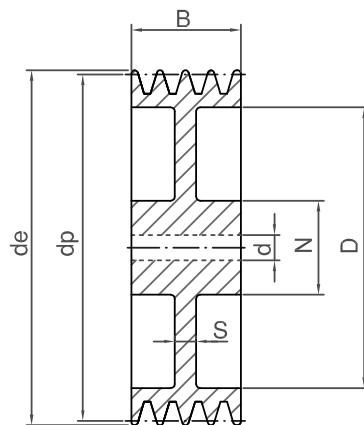

8

POLEAS TRAPECIALES

V-belt pulleys
Poulies trapézoïdales

SPZ

dp	de	Canales / Grooves / Gorges	N	L	D	S	B	d	Fig.	Kg.
50	54	1	40	28			16	10	1	0,40
		2	40	35			28	10	1	0,50
		3					40	10	7	0,55
56	60	1	45	28			16	10	1	0,45
		2	45	35			28	10	1	0,50
		3					40	10	7	0,60
63	67	1	50	28			16	10	1	0,50
		2	50	35			28	10	1	0,60
		3					40	10	7	0,60
71	75	1	50	28			16	10	1	0,58
		2	55	35			28	10	1	0,75
		3					40	10	7	1,00
75	79	1	50	28			16	10	1	0,70
		2	60	35			28	10	1	0,90
		3					40	10	7	1,00
80	84	1	50	28			16	10	1	0,70
		2	60	35			28	10	1	0,95
		3					40	10	7	1,10
85	89	1	50	28			16	10	1	0,70
		2	60	35			28	10	1	1,10
		3					40	15	7	1,40
90	94	1	50	28			16	10	1	0,85
		2	60	35			28	10	1	1,40
		3					40	15	7	1,80
95	99	1	50	28			16	10	1	0,90
		2	60	35			28	15	1	1,50
		3					40	15	7	1,80
100	104	1	50	28			16	10	1	1,00
		2	60	35			28	15	1	1,50
		3					40	15	7	1,90
106	110	1	50	28			16	10	1	1,10
		2	60	35			28	15	1	1,90
		3					40	15	7	2,25
112	116	1	50	28			16	10	1	1,20
		2	60	35			28	15	1	2,00
		3					40	15	7	2,50
118	122	1	50	28	93	8	16	10	3	1,00
		2	60	35	91	8	28	15	3	1,55
		3					40	15	7	2,80
125	129	1	50	28	100	8	16	15	3	1,10
		2	60	35	99	8	28	15	3	1,85
		3					40	15	7	3,10
132	136	1	50	28	106	8	16	15	3	1,16
		2	60	40	106	8	28	15	3	1,90
		3	60	40	106	8	40	15	8	2,20
140	144	1	50	28	114	8	16	15	3	1,30
		2	60	40	114	8	28	15	3	2,00
		3	60	40	114	8	40	15	8	2,45

dp	de	Canales / Grooves / Gorges	N	L	D	S	B	d	Fig.	Kg.
150	154	1	50	28	124	8	16	15	3	1,40
		2	60	40	124	8	28	15	3	2,00
		3	60	40	124	8	40	20	8	2,50
160	164	1	50	32	134	8	16	15	3	1,50
		2	60	40	134	8	28	15	3	2,25
		3	65	45	134	8	40	20	3	3,00
180	184	1	50	32	154	8	16	20	5	1,70
		2	60	40	154	8	28	20	5	2,50
		3	65	45	154	8	40	20	5	3,30
200	204	1	50	32	174	8	16	20	5	2,00
		2	60	40	174	8	28	20	5	2,90
		3	65	45	174	10	40	20	5	3,70
224	228	1	50	32	198	8	16	20	5	2,40
		2	60	40	198	8	28	20	5	3,30
		3	65	45	198	10	40	20	5	4,65
250	254	1	50	32	224	8	16	20	5	2,90
		2	60	40	224	10	28	20	5	3,50
		3	65	45	224	12	40	20	5	5,00
280	284	2	65	45	254	10	28	20	5	5,40

POLEAS TRAPECIALES

V-belt pulleys

Poulies trapézoïdales

SPA

dp	de	Canales Grooves / Gorges	N	L	D	S	B	d	Fig.	Kg.
40	45,5	1	40	35			20	10	1	0,25
50	55,5	1	40	35			20	10	1	0,35
		2	40	45			35	10	1	0,45
56	61,5	1	40	35			20	10	1	0,42
		2	40	45			35	10	1	0,56
60	65,5	1	40	35			20	10	1	0,46
		2	40	45			35	10	1	0,69
63	68,5	1	40	35			20	10	1	0,51
		2	40	45			35	10	1	0,69
71	76,5	1	40	40			20	10	1	0,60
		2	50	45			35	10	1	1,00
75	80,5	1	40	40			20	10	1	0,72
		2	50	45			35	10	1	1,00
80	85,5	1	45	40			20	10	1	0,85
		2	50	45			35	10	1	1,18
85	90,5	1	45	40			20	10	1	0,94
		2	50	45			35	10	1	1,29
90	95,5	1	45	40			20	10	1	1,03
		2	60	45			35	15	1	1,50
95	100,5	1	45	40			20	10	1	1,13
		2	60	45			35	15	1	1,70
100	105,5	1	48	40			20	10	1	1,24
		2	60	45			35	15	1	1,80
106	111,5	1	48	40			20	10	1	1,37
		2	60	45			35	15	1	2,04
112	117,5	1	48	40			20	10	1	1,53
		2	60	45			35	15	1	2,27
125	130,5	1	60	40			20	15	1	2,02
		2	60	45			35	15	1	2,91
132	137,5	1	60	40			20	15	1	2,18
		2	60	45			35	15	1	3,26
140	145,5	1	60	40	107	10	20	15	3	1,97
		2	60	45	107	10	35	15	3	2,50
150	155,5	1	60	40	117	10	20	15	3	2,15
		2	60	45	117	10	35	15	3	2,80
160	165,5	1	60	40	127	10	20	15	3	2,30
		2	60	45	127	10	35	15	3	3,00
170	175,5	1	60	40	137	10	20	15	3	2,50
		2	60	45	137	10	35	15	3	3,30
180	185,5	1	65	40	147	10	20	20	3	2,84
		2	70	50	147	12	35	20	3	4,00
190	195,5	1	70	50	157	12	35	20	3	3,20
		2	70	52	157	12	50	20	3	4,34
200	205,5	1	65	45	167	10	20	20	3	3,60
		2	70	50	167	12	35	20	3	4,66
212	217,5	1	65	40		10	20	20	3	3,60
		2	70	45		12	35	20	3	4,90
224	229,5	1	65	45	192	10	20	20	3	4,00
		2	70	50	192	12	35	20	3	5,48
236	241,5	1		50		12	20	20	3	4,89
		2		50		12	35	20	3	4,50

dp	de	Canales Grooves / Gorges	N	L	D	S	B	d	Fig.	Kg.
125	130,5	1	60	40			20	15	1	2,02
		2	60	45			35	15	1	2,91
132	137,5	1	60	40			20	15	1	2,18
		2	60	45			35	15	1	3,26
140	145,5	1	60	40	107	10	20	15	3	1,97
		2	60	45	107	10	35	15	3	2,50
150	155,5	1	60	40	117	10	20	15	3	2,15
		2	60	45	117	10	35	15	3	2,80
160	165,5	1	60	40	127	10	20	15	3	2,30
		2	60	45	127	10	35	15	3	3,00
170	175,5	1	60	40	137	10	20	15	3	2,50
		2	60	45	137	10	35	15	3	3,30
180	185,5	1	65	40	147	10	20	20	3	2,84
		2	70	50	147	12	35	20	3	4,00
190	195,5	1	70	50	157	12	35	20	3	3,20
		2	70	52	157	12	50	20	3	4,34
200	205,5	1	65	45	167	10	20	20	3	3,60
		2	70	50	167	12	35	20	3	4,66
212	217,5	1	65	40		10	20	20	3	3,60
		2	70	45		12	35	20	3	4,90
224	229,5	1	65	45	192	10	20	20	3	4,00
		2	70	50	192	12	35	20	3	5,48
236	241,5	1		50		12	20	20	3	4,89
		2		50		12	35	20	3	4,50

SPA

dp	de	Canales Grooves / Gorges	N	L	D	S	B	d	Fig.	Kg.
250	255,5	1	75	50	217	12	20	20	3	5,70
		2	75	50	217	12	35	20	3	6,50
		3	80	60	217	12	50	20	3	8,13
		4	90	65	217	18	65	20	3	11,42
		5	90	65	217	20	80	20	4	13,20
280	285,5	1	75	50	247	14	20	20	5	4,56
		2	80	50	247	14	35	20	5	6,40
		3	80	60	247	14	50	20	5	7,93
		4	90	65	247	16	65	20	5	10,30
		5	100	65	247	18	80	25	6	12,69
300	305,5	1	75	50	267	14	20	20	5	5,41
		2	80	50	267	14	35	20	5	6,54
		3	80	60	267	14	50	20	5	8,57
		4	90	65	267	16	65	20	5	10,21
		5	100	65	267	18	80	25	6	13,29
315	320,5	1	75	60	282	14	20	20	5	5,74
		2	80	50	282	14	35	20	5	7,19
		3	90	60	282	14	50	20	5	9,35
		4	90	65	282	16	65	20	5	11,40
		5	100	65	282	18	80	25	6	13,10
355	360,5	1	75	50	322	14	20	20	5	6,47
		2	80	50	322	14	35	20	5	8,20
		3	90	60	322	14	50	20	5	10,94
		4	90	65	322	16	65	25	5	12,66
		5	100	65	322	18	80	25	6	13,90
400	405,5	1	90	50	367	14	20	20	5	6,64
		2	90	50	367	14	35	20	5	10,80
		3	100	60	367	16	50	25	5	13,30
		4	100	65	367	20	65	25	5	16,00
		5	100	65	367	22	80	25	6	19,14
450	455,5	1	90	50	417	14	20	20	5	9,46
		2	100	50	417	14	35	25	5	11,82
		3	100	60	417	16	50	25	5	15,00
		4	105	65	417	20	65	25	6	20,95
		5	105	65	417	22	80	25	6	21,36
500	505,5	1	90	50	467	14	20	20	5	10,84
		2	100	50	467	16	35	25	5	14,00
		3	105	60	467	20	50	25	5	17,04
		4	105	65	467	20	65	25	6	21,12
		5	110	65	467	22	80	25	6	25,58
560	565,5	1	100	50	527	15	20	25	5	14,92
		2	100	50	527	18	35	25	5	18,98
		3	120	65	527	20	50	25	5	25,57
		4	120	65	527	22	65	25	5	27,68
		5	120	80	527	24	80	25	5	
		6	120	80	527	26	95	25	6	
630	635,5	1	100	50	597	16	20	25	5	
		2	110	50	597	18	35	25	5	23,00
		3	120	65	597	20	50	25	5	25,96
		4	120	65	597	22	65	25	5	
		5	120	80	597	24	80	25	5	
		6	120	80	597	26	95	25	6	

SPB

dp	de	Canales Grooves / Gorges	N	L	D	S	B	d	Fig.	Kg.
63	70	1	45	45			25	10	1	0,70
70	77	1	45	45			25	10	1	0,80
		2	45	55			44	10	1	1,00
71	78	3					63	15	7	1,30
80	87	1	50	45			25	10	1	1,00
		2	50	55			44	10	1	1,50
		3					63	15	7	1,70
		4					82	15	7	2,15
85	92						101	15	7	2,60
		1	50	45			25	10	1	1,10
		2	50	55			44	10	1	1,60
90	97	3					63	15	7	1,90
		4					82	15	7	2,20
		5					101	15	7	2,90
		1	50	45			25	10	1	3,48
		2	50	55			44	10	1	1,00
95	102	1	50	45			25	10	1	1,35
100	107	1	52	45			25	10	1	1,60
		2	55	55			44	15	1	2,20
		3					63	15	7	2,90
		4					82	15	7	3,60
		5					101	15	7	4,45
106	113	1		45			25	15	1	1,60
112	119	2		55			44	15	1	2,50
		1	55	45			25	15	1	2,00
		2	60	55			44	15	1	2,80
		3					63	15	7	3,60
		4					82	20	7	4,60
118	125	5					101	20	7	5,60
		1	55	45			25	15	1	2,00
		2	60	55			44	15	1	3,20
		3					63	15	7	4,10
		4					82	20	7	5,20
		5					101	20	7	6,50
120	127	6					120	20	7	7,50
		1	55	45			25	15	1	
		2	60	55			44	15	1	
		3					63	15	7	
		4					82	20	7	
		5					101	20	7	
125	132	6					120	20	7	
		1	55	45			25	10	1	2,30
		2	60	55			44	15	1	3,50
		3		60	83		63	15	2	4,50
		4		60	83		82	20	2	5,00
		5		60	83		101	20	2	5,75
132	139	6		60	83		120	20	2	6,30
		1	60	45			25	15	1	2,50
		2	60	55			44	15	1	3,80
		3		60	88		63	15	2	5,00
		4		60	88		82	20	2	5,60
		5		60	88		101	20	2	6,50
140	147	6		60	88		120	20	2	7,00
		1	65	45			25	20	1	2,90
		2	65	55			44	20	1	4,30
		3		60	98		63	20	2	5,80
		4		60	98		82	20	2	6,40
		5		60	98		101	20	2	7,20
6		60	98		120	20	2	7,71		

POLEAS TRAPECIALES

V-belt pulleys

Poulies trapézoïdales

SPB

dp	de	Canales Grooves / Gorges	N	L	D	S	B	d	Fig.	Kg.
150	157	1	60	45			25	20	1	3,30
		2	60	55			44	20	1	5,00
		3		60	108		63	20	2	6,70
		4		60	108		82	20	2	7,50
		5		60	108		101	20	2	8,30
		6		60	108		120	20	2	9,00
160	167	1	65	45	118	12	25	20	3	2,70
		2	70	55	118	12	44	20	3	4,10
		3		60	118		63	20	2	7,60
		4		60	118		82	20	2	8,40
		5		60	118		101	20	2	9,30
		6		65	118		120	20	2	10,50
170	177	1	65	45	128	12	25	20	3	3,00
		2	70	55	128	12	44	20	3	4,40
		3	70	60	128	30	63	20	4	6,70
		4	70	60	128	30	82	20	4	6,80
		5	70	60	128	30	101	20	4	8,40
		6	70	65	128	40	120	20	4	9,50
180	187	1	65	45	138	12	25	20	3	3,40
		2	70	55	138	12	44	20	3	3,50
		3	80	60	138	18	63	20	4	6,80
		4	80	60	138	30	82	20	4	8,50
		5	80	70	138	40	101	20	4	10,10
		6	80	70	138	40	120	20	4	11,50
190	197	1	65	45	148	12	25	20	3	3,60
		2	70	55	148	12	44	20	3	5,00
200	207	1	70	45	158	14	25	20	3	3,80
		2	70	55	158	12	44	20	3	5,60
		3	80	60	158	18	63	20	4	7,70
		4	88	60	158	25	82	20	4	9,80
		5	96	70	158	35	101	25	4	13,00
		6	96	70	158	40	120	25	4	12,50
212	219	1	70	45	170	14	25	20	3	4,65
		2	77	55	170	14	44	20	3	6,50
		3	80	60	170	18	63	20	4	8,50
		4	88	60	170	25	82	20	4	10,90
		5	96	70	170	30	101	25	4	12,90
		6	104	80	170	45	120	25	4	17,50
224	231	1	70	5	183	14	25	20	3	5,10
		2	77	55	183	14	44	20	3	7,00
		3	80	60	183	18	63	20	4	9,20
		4	88	60	183	25	82	20	4	11,60
		5	96	70	183	25	101	25	4	14,00
		6	104	80	183	30	120	25	4	17,00
250	257	1	70	50	208	14	25	20	3	6,20
		2	77	55	208	14	44	20	3	8,40
		3	80	60	208	18	63	20	4	10,80
		4	96	65	208	25	82	25	4	14,40
		5	104	75	208	25	101	25	4	17,30
		6	104	80	208	25	120	25	4	19,00
280	287	1	76	50	238	14	25	20	3	7,60
		2	80	55	238	14	44	20	3	10,00
		3	90	60	238	18	63	20	4	13,30
		4	96	65	238	25	82	25	4	17,00
		5	104	75	238	25	101	25	4	20,00
		6	104	80	238	25	120	25	4	21,90

dp	de	Canales Grooves / Gorges	N	L	D	S	B	d	Fig.	Kg.
300	307	1	76	50	258	15	25	20	5	7,40
		2	80	55	258	15	44	20	5	10,50
		3	90	60	258	18	63	20	6	12,70
		4	96	65	258	20	82	25	6	15,70
		5	104	75	258	22	101	25	6	18,00
		6	104	80	258	24	120	25	6	20,80
315	322	1	76	50	273	15	25	20	5	7,40
		2	88	60	273	15	44	20	5	10,50
		3	90	60	273	18	63	20	6	13,00
		4	96	65	273	20	82	25	6	15,70
		5	104	75	273	22	101	25	6	19,00
		6	120	90	273	24	120	25	6	24,50
355	362	1	80	50	313	15	25	20	5	8,60
		2	88	60	313	15	44	20	5	11,60
		3	92	60	313	18	63	25	6	14,50
		4	96	65	313	20	82	25	6	18,00
		5	104	75	313	22	101	25	6	21,30
		6	120	90	313	24	120	25	6	26,70
400	407	1	85	55	358	18	25	20	5	12,30
		2	88	60	358	18	44	20	5	15,00
		3	96	65	358	22	63	25	5	19,10
		4	104	75	358	24	82	25	6	23,50
		5	112	85	358	26	101	25	6	28,00
		6	120	100	358	28	120	25	6	34,00
425	432	3	96	65	383	22	63	20	5	20,60
		4	104	75	383	24	82	25	6	25,50
		5	112	85	383	26	101	25	6	30,30
450	457	1	90	60	408	18	25	20	5	14,00
		2	90	60	408	18	44	20	5	17,00
		3	96	65	408	22	63	25	5	22,30
		4	104	75	408	24	82	25	6	27,00
		5	112	85	408	26	101	25	6	28,50
		6	120	100	408	28	120	25	6	37,50
500	507	1	100	60	458	18	25	25	5	14,00
		2	100	65	458	20	44	25	5	21,50
		3	104	75	458	24	63	25	5	22,30
		4	112	85	458	28	82	25	5	27,00
		5	120	90	458	30	101	25	6	33,80
		6	128	105	458	33	120	25	6	47,20
560	567	1	100	60	518	18	25	25	5	16,00
		2	100	65	518	20	44	25	5	24,00
		3	104	75	518	24	63	25	5	32,00
		4	112	85	518	28	82	25	5	39,10
		5	120	90	518	30	101	25	6	44,50
		6	128	105	518	33	120	25	6	55,70
600	607	1	100	60	558	18	25	25	5	21,00
		2	100	65	558	20	44	25	5	
		3	104	75	558	24	63	25	5	
		4	115	85	558	28	82	25	5	
		5	120	90	558	30	101	25	6	
		6	129	105	558	33	120	25	6	
630	637	1	100	60	588	18	25	25	5	18,50
		2	100	65	588	20	44	25	5	26,50
		3	105	75	588	26	63	25	5	35,00
		4	120	85	588	28	82	25	5	44,00
		5	128	90	588	30	101	25	6	
		6	140	105	588	33	120	25	6	

SPC

dp	de	Canales Grooves / Gorges	N	L	D	S	B	d	Fig.	Kg.	
100	109,6	1	60	50			34,0	15	1	1,80	
120	129,6	1	65	50			34,0	15	1	2,70	
		2					59,5	15	7	4,70	
140	149,6	1	70	50			34,0	20	1	3,30	
		2					59,5	20	7	5,50	
		3		65	83			85,0	20	2	6,50
		4		80	83			110,5	20	2	8,30
150	159,6	1	70	50			34,0	20	1	4,00	
		2					59,5	20	7	6,50	
		3		65	93			85,0	20	2	7,90
		4		80	93			110,5	20	2	9,85
		5		96	93			136,0	20	2	14,40
160	169,6	1	72	50	103		34,0	20	1	4,70	
		2			103			59,5	20	7	7,15
		3		65	103			85,0	20	2	8,70
		4		80	103			110,5	20	2	11,10
		5		96	103			136,0	20	2	15,80
		6		96	103			161,5	20	2	16,60
180	189,6	1	76	50	123	16	34,0	20	3	4,00	
		2	80		123	30	59,5	20	8	6,70	
		3	82	65	123	35	85,0	20	4	10,00	
		4	82	80	123	60	110,5	20	4	10,80	
		5	82	96	123	75	136,0	20	4	16,20	
		6	82	96	123	75	161,5	20	4	15,50	
200	209,6	1	76	50	143	16	34,0	20	3	6,00	
		2	80	60	143	20	59,5	20	3	8,50	
		3	86	65	143	25	85,0	20	4	10,50	
		4	90	90	143	70	110,5	20	4	13,65	
		5	90	100	143	80	136,0	25	4	16,10	
		6	90	100	143	80	161,5	25	4	18,50	
224	233,6	1	86	50	168	16	34,0	20	3	7,00	
		2	88	60	168	18	59,5	20	3	10,00	
		3	90	70	168	21	85,0	20	4	12,90	
		4	90	90	168	so	110,5	25	4	19,00	
		5	90	100	168	60	136,0	25	4	22,00	
		6	90	100	168	60	161,5	25	4	24,70	
250	259,6	1	86	50	193	16	34,0	20	3	7,80	
		2	92	60	193	18	59,5	20	3	11,70	
		3	92	70	193	21	85,0	20	4	15,30	
		4	100	90	193	30	110,5	25	4	21,80	
		5	102	100	193	50	136,0	25	4	26,60	
		6	102	100	193	50	161,5	25	4	27,65	
280	289,6	1	86	50	223	16	34,0	20	3	9,50	
		2	92	60	223	18	59,5	20	3	13,15	
		3	92	70	223	21	85,0	20	4	17,70	
		4	100	90	223	25	110,5	25	4	22,10	
		5	102	100	223	40	136,0	25	4	27,60	
		6	102	100	223	40	161,5	25	4	32,40	
300	309,6	1	86	50	243	16	34,0	20	3	7,40	
		2	92	60	243	18	59,5	20	3	13,30	
		3	92	70	243	21	85,0	20	4	19,80	
		4	100	90	243	25	110,5	25	4		
		5	104	100	243	25	136,0	25	4		
		6	104	100	243	25	161,5	25	4		

dp	de	Canales Grooves / Gorges	N	L	D	S	B	d	Fig.	Kg.
315	324,6	1	92	50	258	16	34,0	20	5	9,75
		2	92	60	258	18	59,5	20	5	13,50
		3	92	70	258	22	85,0	25	6	17,50
		4	110	90	258	25	110,5	25	4	27,50
		5	112	100	258	25	136,0	25	4	28,50
		6	112	100	258	28	161,5	25	4	
335	344,6	1	100	50	283	16	34,0	20	5	
		2	100	60	283	18	59,5	20	5	
		3	100	70	283	22	85,0	25	6	
		4	114	90	283	25	110,5	25	6	
		5	114	100	283	28	136,0	25	6	
		6	114	100	283	30	161,5	25	6	
355	364,6	1	110	50	298	16	34,0	20	5	
		2	110	60	298	18	59,5	25	5	15,21
		3	110	70	298	22	85,0	25	6	22,50
		4	114	90	298	25	110,5	25	6	29,00
		5	114	100	298	28	136,0	25	6	33,30
		6	114	100	298	30	161,5	25	6	39,80
400	409,6	1	110	60	343	18	34,0	25	5	12,20
		2	110	70	343	20	59,5	25	5	21,00
		3	114	90	343	24	85,0	25	5	27,70
		4	114	90	343	26	110,5	25	6	39,90
		5	120	100	343	28	136,0	25	6	40,70
		6	120	100	343	30	161,5	25	6	
450	459,6	1	110	60	393	18	34,0	25	5	
		2	110	70	393	20	59,5	25	5	32,30
		3	114	90	393	24	85,0	25	5	
		4	120	90	393	28	110,5	25	6	
		5	120	100	393	30	136,0	25	6	
		6	120	100	393	32	161,5	25	6	
500	509,6	1	114	60	443	18	34,0	25	5	
		2	114	70	443	20	59,5	25	5	
		3	114	90	443	24	85,0	25	5	
		4	126	90	443	28	110,5	25	6	44,50
		5	126	100	443	30	136,0	25	6	
		6	126	100	443	32	161,5	25	6	
560	569,6	1	114	60	503	20	34,0	25	5	
		2	114	70	503	24	59,5	25	5	
		3	114	90	503	28	85,0	25	5	
		4	130	100	503	30	110,5	25	6	52,00
		5	130	100	503	32	136,0	25	6	
		6	130	100	503	35	161,5	25	6	
600	609,6	1	114	60	543	20	34,0	25	5	
		2	114	70	543	24	59,5	25	5	
		3	114	90	543	28	85,0	25	5	
		4	130	90	543	30	110,5	25	6	
		5	130	100	543	32	136,0	25	6	
		6	130	100	543	35	161,5	25	6	
630	639,6	1	114	60	573	20	34,0	25	5	
		2	114	70	573	24	59,5	25	5	
		3	114	90	573	28	85,0	25	5	
		4	130	90	573	30	110,5	25	6	
		5	130	100	573	32	136,0	25	6	
		6	130	100	573	35	161,5	25	6	

POLEAS TRAPECIALES PARA TAPER

V-belt taper bored pulleys

Poulies trapézoïdales pour moyeu amovible

Diseñadas para ser utilizadas con correas V de sección estrecha y correas de sección clásica

Designed to be used with thin section V belts, and classical section belts

Pour courroies type V de section étroite et classique



Perfil Sharpe Profil	Dp	β°	S	F	E	C	H
SPZ	≤ 80	34	8,5	8	12	2	11
	≥ 80	38					
SPA	≤ 118	34	11	10	15	2,8	13,8
	≥ 118	38					
SPB	≤ 190	34	14	12,5	19	3,5	17,5
	≥ 190	38					
SPC	≤ 315	34	19	17	25,5	4,8	23,8
	≥ 315	38					

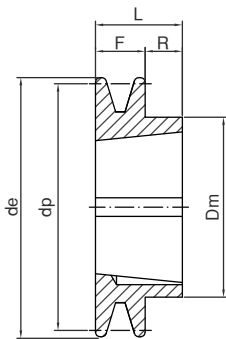
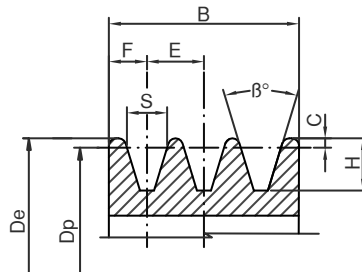

1

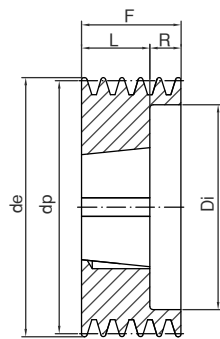

2

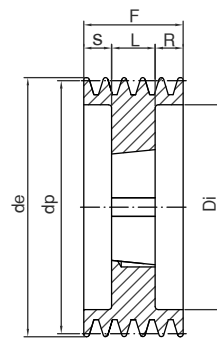

3

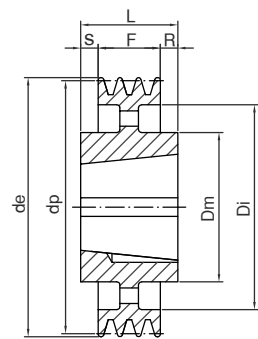

4

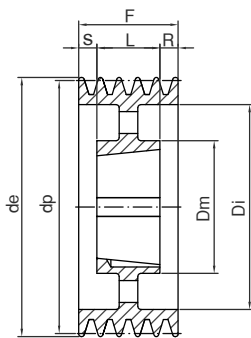

5

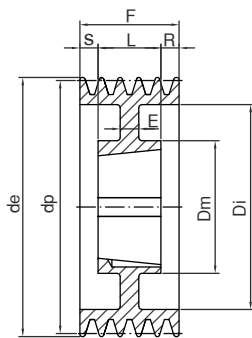

6

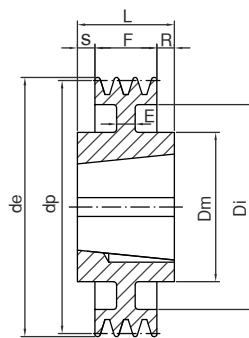

7

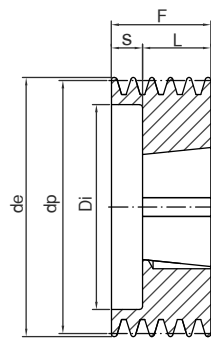

8

POLEAS TRAPECIALES PARA TAPER

V-belt taper bored pulleys

Poulies trapézoïdales pour moyeu amovible

SPZ/XPZ/Z

dp	de	Canales Grooves / Gorges	Taper	Ø max.	F	J	S	L	Dm	Fig.	Kg.
56	60	1	1008	25	37	32	12	25		8	0,50
	60	2	1008	25	49	33	27	22		8	0,57
60	64	1	1008	25	22	22		22		1	0,31
	64	2	1108	28	49	36	27	22		8	0,66
63	67	1	1108	28	16			22	56	1	0,27
	67	2	1108	28	28	40	6	22		8	0,31
	67	3	1108	28	40	40		22		8	0,44
67	71	1	1108	28	16			22	60	1	0,32
	71	2	1108	28	28	42	6	22		8	0,40
	71	3	1108	28	40	42	18	22		8	0,53
71	75	1	1108	28	16			22	60	1	0,36
	75	2	1108	28	28	42	6	22		8	0,56
	75	3	1108	28	40	42	18	22		8	0,62
75	79	1	1108	28	16			22	60	1	0,44
	79	2	1210	32	28	51	3	25		8	0,42
	79	3	1210	32	40	51	15	25		8	0,58
80	84	1	1210	32	16			25	75	1	0,50
	84	2	1210	32	28	51	3	25		8	0,54
	84	3	1210	32	40	51	15	25		8	0,73
	84	4	1210	32	52	51	27	25		8	0,9
85	89	1	1210	32	16			25	80	1	0,77
	89	2	1610	42	28	60	3	25		8	0,53
	89	3	1610	42	40	60	15	25		8	0,72
	89	4	1610	42	52	60	27	25		8	0,96
	89	5	1610	42	64	60	39	25		8	1,15
90	94	1	1210	32	16			25	80	1	0,86
	94	2	1610	42	28	61	3	25		8	0,81
	94	3	1610	42	40	61	15	25		8	0,87
	94	4	1610	42	52	61	27	25		8	1,1
	94	5	1610	42	64	61	39	25		8	1,29
95	99	1	1210	32	16			25	85	1	0,84
	99	2	1610	42	28	66	3	25		8	0,81
	99	3	1610	42	40	66	15	25		8	0,99
	99	4	1610	42	52	66	27	25		8	1,26
	99	5	1610	42	64	66	39	25		8	1,46
100	104	1	1210	32	16			25	85	1	0,92
	104	2	1610	42	28	71	3	25		8	0,97
	104	3	1610	42	40	71	15	25		8	1,17
	104	4	1610	42	52	71	27	25		8	1,36
	104	5	2012	50	64	71	32	32		8	1,61
106	110	1	1610	42	16			25	92	1	0,95
	110	2	1610	42	28	76	3	26		8	1,14
	110	3	1610	42	40	76	15	25		8	1,35
	110	4	1610	42	52	76	27	25		8	1,88
	110	5	2012	50	64	76	32	32		8	2,03
	110	6	2012	50	76	76	44	32		8	2,00

dp	de	Canales Grooves / Gorges	Taper	Ø max.	F	J	S	L	Dm	Fig.	Kg.
112	116	1	1610	42	16			25	92	1	1,07
	116	2	1610	42	28	83	3	25		8	1,34
	116	3	2012	50	40	83	8	32		8	1,42
	116	4	2012	50	52	83	20	32		8	1,66
	116	5	2012	50	64	83	32	32		8	2,01
	116	6	2012	50	76	83	44	32		8	2,62
118	122	1	1610	42	16			25	92	1	1,2
	122	2	1610	42	28	90	3	25		8	1,52
	122	3	2012	50	40	90	8	32		8	1,7
	122	4	2012	50	52	90	20	32		8	1,94
	122	5	2012	50	64	90	32	32		8	2,29
	122	6	2517	60	76	90	31	45			2,27
125	129	1	1610	42	16			25	92	1	1,51
	129	2	1610	42	28	96	3	25		8	1,83
	129	3	2012	50	40	96		32		2	2
	129	4	2012	50	52	96		32		2	2,77
	129	5	2012	50	64	96	32	32		8	3,12
	129	6	2517	60	76	96	31	45		8	2,71
132	136	1	1610	42	16			25	92	1	1,69
	136	2	1610	42	28	103	3	25		8	2,02
	136	3	2012	50	40	103		32		2	2,32
	136	4	2012	50	52	103		32		2	2,8
	136	5	2517	60	64	103	19	45		8	3
	136	6	2517	60	76	103	31	45		8	3,2
140	144	1	1610	42	16			25	92	1	1,87
	144	2	1610	42	28	111	3	25		8	2,41
	144	3	2012	50	40	111		32		2	2,73
	144	4	2012	50	52	111		32		2	3,1
	144	5	2517	60	64	111		45		2	3,45
	144	6	2517	60	76	111		45		2	3,85
	144	8	2517	60	100	111	27,5	45		3	4,63
150	154	1	1610	42	16			25	92	1	1,95
	154	2	2012	50	28	121		32	112	1	3,03
	154	3	2012	50	40	121		32		2	3,2
	154	4	2517	60	52	121		45		2	3,8
	154	5	2517	60	64	121		45		2	4,2
	154	6	2517	60	76	121		45		2	4,58
160	164	1	1610	42	16			25	92	1	2,22
	164	2	2012	50	28	131		32	112	1	3,73
	164	3	2012	50	40	131		32		2	4,32
	164	4	2517	60	52	131		45		2	4,91
	164	5	2517	60	64	131		45		2	5,06
	164	6	2517	60	76	131		45		2	5,51
164	8	2517	60	100	131	27,5	45		3	6,39	

POLEAS TRAPECIALES PARA TAPER
 V-belt taper bored pulleys
 Poulies trapézoïdales pour moyeu amovible

SPZ/XPZ/Z

dp	de	Canales / Grooves	Taper	Ø max.	F	J	S	L	Dm	Fig.	Kg.	
170	174	1	1610	42	16			25	92	1	2,5	
	174	2	2012	50	28			32	112	1	3,78	
	174	3	2012	50	40	141	4,0	32		3	4,42	
	174	4	2517	60	52	141		45		2	5,44	
	174	5	2517	60	64	141		45		2	5,91	
	174	6	2517	60	76	141		45		2	6,33	
180	184	1	1610	42	16	152		25	92	7	2,23	
	184	2	2012	50	28	152		32	112	7	3,39	
	184	3	2012	50	40	152		32	105	6	4,67	
	184	4	2517	60	52	152		45		2	6,3	
	184	5	2517	60	64	151		45		2	6,85	
	184	6	2517	60	76	151	15,5	45		3	7,27	
190	194	1	1610	42	16	162		32	92	7	3,03	
	194	2	2012	50	28	162		32	112	7	3,6	
	194	3	2012	50	40	162	4,0	32	112	6	4,12	
	194	4	2517	60	52	161	3,5	45		3	7,25	
	194	5	2517	60	64	161	9,5	45		3	7,92	
	194	6	2517	60	76	161	15,5	45	124	3	9,25	
200	204	1	2012	50	16	171		32	112	7	3,66	
	204	2	2012	50	28	171		32	112	7	4,04	
	204	3	2012	50	40	171	4,0	32	112	6	4,52	
	204	4	2517	60	52	171	3,5	45	124	6	5,5	
	204	5	2517	60	64	171	9,5	45		3	8,81	
	204	6	2517	60	76	171	15,5	45	124	3	10,54	
200	204	8	3020	75	100	171	24,5	51		3	10,08	
	224	228	1	2012	50	16	195		32	112	7	7,59
		228	2	2012	50	28	195		32	112	4	4,23
		228	3	2012	50	40	195	4,0	32	112	6	5,43
		228	4	2517	60	52	195	3,5	45	124	6	6,9
		228	5	2517	60	64	195	9,5	42	124	6	8,75
228		6	2517	60	76	195	15,5	45	124	6	9,65	
250	254	1	2012	50	16	221	8,0	32	112	4	4,15	
	254	2	2012	50	28	221	2,0	32	112	4	5,05	
	254	3	2012	50	40	221	4,0	32	112	5	6,1	
	254	4	2517	60	52	221	3,5	45	124	6	7,5	
	254	5	2517	60	64	221	9,5	45	124	6	8,7	
	254	6	2517	60	76	221	15,5	45	124	6	12,71	
280	284	1	2012	50	16	251	8,0	32	112	4	6,02	
	284	2	2012	50	28	251	2,0	32	112	4	6,99	
	284	3	2517	60	40	251	2,5	45	124	4	9,25	
	284	4	2517	60	52	251	3,5	45	124	6	10,39	
	284	5	2517	60	64	251	9,5	45	124	6	11,76	
	284	6	2517	60	76	251	15,5	45	124	6	11,37	
280	284	8	3020	75	100	251	24,5	51	146	6	14,69	

dp	de	Canales / Grooves	Taper	Ø max.	F	J	S	L	Dm	Fig.	Kg.	
315	319	1	2012	50	16	286,0	8,0	32	112	4	7,3	
	319	2	2012	50	28	286,0	2,0	32	112	4	8,44	
	319	3	2517	60	40	286,0	2,5	45	124	4	11,29	
	319	4	2517	60	52	286,0	3,5	45	124	5	13,09	
	319	5	2517	60	64	286,0	9,5	45	124	5	15,2	
	319	6	2517	60	76	286,0	15,5	45	124	6	13	
355	359	1	2012	50	16	326,0	8,0	32	112	4	5,73	
	359	2	2012	50	28	326,0	2,0	32	112	4	7,8	
	359	3	2517	60	40	326,0	2,5	45	124	4	11,27	
	359	4	2517	60	52	326,0	3,5	45	124	5	12,2	
	359	5	2517	60	64	326,0	9,5	45	124	5	13,96	
	359	6	2517	60	76	326,0	15,5	45	124	5	16,3	
400	404	1	2012	50	16	371,0	9,0	32	112	4	7,23	
	404	2	2517	60	28	371,0	8,5	45	124	4	9,57	
	404	3	2517	60	40	371,0	2,5	45	124	4	11,56	
	404	4	2517	60	52	371,0	3,5	45	124	5	14,21	
	404	5	3020	75	64	371,0	6,5	51	146	5	12,95	
	404	6	3030	75	76	371,0		76	146	5	15,44	
450	404	8	3030	75	100	371,0	12,5	76	146	5	18,2	
	454	1	2517	60	16	421,0	14,5	45	124	4	8,76	
	454	2	2517	60	28	421,0	8,5	45	124	4	11,18	
	454	3	2517	60	40	421,0	2,5	45	124	4	14,66	
	454	4	3020	75	52	421,0	0,5	51	146	5	16,8	
	454	5	3020	75	64	421,0	6,5	51	146	5	19,7	
500	454	6	3030	75	76	421,0		76	146	5	18,45	
	454	8	3535	90	100	420,0	5,5	89	175	5	28,92	
	504	3	2517	60	40	471,0	2,5	45	124	4	19,73	
	504	4	3020	75	52	471,0	0,5	51	146	5	21,4	
	504	5	3030	75	64	471,0	6,0	76	146	4	22,27	
	504	6	3030	75	76	471,0		76	146	5	20,79	
630	634	3	3020	60	40	601,0	5,5	51	150	4	19,25	
	634	4	3030	75	52	601,0	12,0	76	146	4	31,01	
	634	5	3030	90	64	601,0	6,0	76	146	4	28,1	
	634	6	3535	90	76	601,0	6,5	89	175	4	29,98	
	800	804	3	3020	75	40	770,0	5,5	51	146	4	24,55
		804	4	3030	75	52	770,0	12,0	76	146	4	30,45
804		5	3535	90	64	770,0	12,5	89	178	4	38,62	
804		6	3535	90	76	770,0	6,5	89	178	4	43,57	

POLEAS TRAPECIALES PARA TAPER

V-belt taper bored pulleys

Poulies trapézoïdales pour moyeu amovible

SPA/XPA/A

dp	de	Canales Grooves / Gorges	Taper	Ø max.	F	J	S	L	Dm	Fig.	Kg.
67	72,5	1	1108	28	20			22	56	1	0,32
	72,5	2	1108	28	35	37	13	22		8	0,46
71	76,5	1	1108	28	20			22	60	1	0,37
	76,5	2	1108	28	35	40	13	22		8	0,55
	76,5	3	1108	28	50	40	28	22		8	0,74
75	80,5	1	1108	28	20			22	56	1	0,43
	80,5	2	1108	28	35	44	13	22		8	0,63
	80,5	3	1108	28	50	44	28	22		8	0,83
80	85,6	1	1210	32	20			25	75	1	0,53
	85,6	2	1210	32	35	50	10	25		8	0,63
	85,6	3	1210	32	50	50	25	25		8	0,83
85	90,5	1	1210	32	20			25	80	1	0,66
	90,5	2	1210	32	35	55	10	25		8	0,73
	90,5	3	1210	32	50	55	25	25		8	0,99
90	99,5	1	1210	32	20			25	80	1	0,75
	99,5	2	1610	42	35	59	10	25		8	0,74
	99,5	3	1610	42	50	59	25	25		8	1,07
	99,5	4	1615	42	65	50	27	38		8	1,37
95	100,5	1	1210	32	20			25	85	1	0,85
	100,5	2	1610	42	35	63	10	25		8	0,91
	100,5	3	1610	42	50	63	25	25		8	1,23
	100,5	4	1615	42	65	63	27	38		8	1,61
100	105,5	1	1610	42	20			25	85	1	0,80
	105,5	2	1610	42	35	66	10	25		8	1,05
	105,5	3	1610	42	50	66		25		2	1,38
	105,5	4	1615	42	65	66		38		2	1,82
	105,5	5	1615	42	80	66		38		2	1,92
	105,5	6	1610	42	95	66	30	25		3	2,23
106	111,5	1	1610	42	20			25	92	1	0,90
	111,5	2	1610	42	35	72	10	25		8	1,24
	111,5	3	1610	42	50	72		25		2	1,57
	111,5	4	2012	50	65	72	33	32		8	1,76
	111,5	5	2012	50	80	72	48	32		8	2,17
	111,5	6	2012	50	95	72	63	32		8	2,53
112	117,5	1	1610	42	20			25	92	1	1,05
	117,5	2	1610	42	35	78	10	25		8	1,43
	117,5	3	2012	50	50	78	18	32		8	1,63
	117,5	4	2012	50	65	78	33	32		8	2,00
	117,5	5	2012	50	80	78	48	32		8	2,41
	117,5	6	2012	50	95	78	6	32		8	2,86
118	123,5	1	1610	42	20			25	92	1	1,20
	123,5	2	1610	42	35	84	10	25		8	1,63
	123,5	3	2012	50	50	84		32		2	1,91
	123,5	4	2012	50	65	84		32		2	2,30
	123,5	5	2012	50	80	84		32		2	2,70
	123,5	6	2012	50	95	84	63	32		8	3,14

dp	de	Canales Grooves / Gorges	Taper	Ø max.	F	J	S	L	Dm	Fig.	Kg.
125	130,5	1	1610	42	20			25	92	1	1,40
	130,5	2	1610	42	35	91	10	25		8	2,00
	130,5	3	2012	50	50	91		32		2	2,32
	130,5	4	2012	50	65	91		32		2	2,74
	130,5	5	2012	50	80	91	24	32		3	3,11
	130,5	6	2012	50	95	91	31	32		3	3,71
132	137,5	1	1610	42	20			25	92	1	1,55
	137,5	2	2012	50	35	98	3	32		8	2,17
	137,5	3	2012	50	50	98		32		2	2,67
	137,5	4	2517	60	65	98		45		2	2,86
	137,5	5	2517	60	80	98	17,5	45		3	3,25
	137,5	6	2517	60	95	98	25	45		3	3,60
140	145,5	1	1610	42	20			25	92	1	1,77
	145,5	2	2012	50	35	106	3	32		8	2,7
	145,5	3	2517	60	50	106	5	45		8	3,19
	145,5	4	2517	60	65	106		45		2	3,50
	145,5	5	2517	60	80	106	17,5	45		3	3,90
	145,5	6	2517	60	95	106	25	45		3	4,60
150	155,2	1	1610	42	20			25	92	1	2,10
	155,2	2	2012	50	35	116	3	32		8	3,20
	155,2	3	2517	60	50	116	5	45		8	3,67
	155,2	4	2517	60	65	116		45		2	4,20
	155,2	5	2517	60	80	116	17,5	45		3	4,67
	155,2	6	2517	60	95	116	25	45		3	5,36
160	165,5	1	1610	42	20			25	92	1	2,32
	165,5	2	2012	50	35	125	3	32		8	3,87
	165,5	3	2517	60	50	125	5	45		8	4,42
	165,5	4	2517	60	65	125		45		2	5,09
	165,5	5	2517	60	80	125	17,5	45		3	5,61
	165,5	6	2517	60	95	125	25	45		3	6,37
170	175,5	1	1610	42	20			25	92	1	2,61
	175,5	2	2012	50	35	135	3	32		8	4,41
	175,5	3	2517	60	50	135	5	45		8	5,25
	175,5	4	2517	60	65	135		45		2	5,92
	175,5	5	2517	60	80	135	17,5	45		3	6,52
180	185,5	1	1610	42	20	145		25	92	7	2,38
	185,5	2	2012	50	35	146	1,5	32	108	6	5,10
	185,5	3	2517	60	50	146	5	45		8	6,30
	185,5	4	2517	60	65	146		45		2	7,00
	185,5	5	3020	75	80	146		51		3	6,75
	185,5	6	3020	75	95	146	22	51		3	7,55
190	195,5	1	1610	42	20	156		25	92	7	2,50
	195,5	2	2012	50	35	156	1,5	32	108	6	3,53
	195,5	3	2517	60	50	156	5	45		8	7,05
	195,5	4	2517	60	65	156		45		2	7,80
	195,5	5	3020	75	80	156	14,5	51		2	7,95

POLEAS TRAPECIALES PARA TAPER

V-belt taper bored pulleys

Poulies trapézoïdales pour moyeu amovible

SPB/XPB/B

dp	de	Canales Grooves / Gorges	Taper	Ø max.	F	J	S	L	Dm	Fig.	Kg.	
100	107,6	1	1610	42	25			25		1	0,84	
	107,6	2	1610	42	44	62	19	25		8	1,33	
	107	3	1610	42	63	62	38	25		8	1,77	
106	113	1	1610	42	25			25		1	0,97	
	113	2	1610	42	44	67	19	25		8	1,41	
	113	3	1610	42	63	67	38	25		8	1,9	
112	119	1	1610	42	25			25		1	1,23	
	119	2	1610	42	44	72	19	25		8	1,36	
	119	3	1610	42	63	72	38	25		8	2,27	
118	125	1	1610	42	25			25		1	1,3	
	125	2	1610	42	44	78	19	25		2	1,9	
	125	3	1610	42	63	78	38	25		2	2,5	
125	132	1	1610	42	25			25		1	1,62	
	132	2	2012	50	44	82		32		2	2,34	
	132	3	2012	50	63	82		32		2	4,5	
	132	4	2012	50	82	82	25	32		3	3,15	
132	132	5	2012	50	101	87	69	32		8	3,9	
	139	1	1610	42	25			25		1	1,8	
	139	2	2012	50	44	89		32		2	2,7	
	139	3	2012	50	63	89		32		2	3,1	
132	139	4	2012	50	82	89	25	32		3	4,05	
	139	5	2517	60	101	94	56	45		8	3,79	
	140	147	1	1610	42	25			25		1	2,13
		147	2	2012	50	44	97		32		2	2,69
147		3	2012	50	63	97		32		2	3,55	
147		4	2517	60	82	100	18,5	45		3	3,94	
147		5	2517	60	101	97	28,0	45		3	4,99	
147		6	2517	60	120	100	37,5	45		3	6,13	
150	157	1	1610	42	25			25		1	2,57	
	157	2	2012	50	44	107		32		2	3,68	
	157	3	2517	60	63	107		45		2	4,05	
	157	4	2517	60	82	107	18,5	45		3	5,56	
	157	5	2517	60	101	107	28	45		3	6,08	
	157	6	2517	60	120	107	37,5	45		3	7,14	
160	167	1	1610	42	25			25		1	3,03	
	167	2	2012	50	44	117		32		2	3,8	
	167	3	2517	60	63	117		45		2	4,87	
	167	4	2517	60	82	117	18,5	45		3	6,01	
	167	5	2517	60	101	117	28	45		3	6,96	
	167	6	3020	75	120	117	34,5	51		3	6,1	
	167	8	3020	75	158	123	53,5	51		3	7,51	
170	177	1	1610	42	25			25		1	3,33	
	177	2	2012	50	44	127		32		2	4,73	
	177	3	2517	60	63	127		45		2	5,91	
	177	4	2517	60	82	127	18,5	45		3	6,7	
	177	5	3020	75	101	127	25	51		3	7	
	177	6	3020	75	120	127	34,5	51		3	7,55	
	177	8	3020	75	158	127	41	76		3	9,58	

dp	de	Canales Grooves / Gorges	Taper	Ø max.	F	J	S	L	Dm	Fig.	Kg.	
180	187	1	1610	42	25	132		25	90	6	3,8	
	187	2	2517	60	44			45	120	1	5,58	
	187	3	2517	60	63	137		45		2	7	
	187	4	2517	60	82	137	18,5	45		3	7,7	
	187	5	3020	75	101	137	25	51		3	7,85	
	187	6	3020	75	120	137	34,5	51		3	8,9	
	187	8	3030	75	158	137	41	76		3	10,85	
	190	197	1	2012	50	25	147	3,5	32	104	7	4,6
197		2	2517	60	44			45	120	1	5,86	
197		3	2517	60	63	147		45		2	7,71	
197		4	2517	60	82	147	18,5	45		3	8,82	
197		5	3020	75	101	147	25	51		3	9	
197		6	3020	75	120	147	34,5	51		3	10,24	
197		8	3030	75	158	147	41	76		3	13,25	
200	207	1	2012	50	25	157	3,5	32	104	7	5,61	
	207	2	2517	60	44			45	117	1	7,5	
	207	3	2517	60	63	157		45		2	8,68	
	207	4	3020	75	82	157	15,5	51		3	8,5	
	207	5	3020	75	101	157	25	51		3	10,45	
	207	6	3020	75	120	157	34,5	51		3	9,95	
	207	8	3535	90	158	157	34,5	89		3	13,2	
	212	219	1	2012	50	25	169	3,5	32	104	7	5,07
219		2	2517	60	44	169		45	117	7	7	
219		3	2517	60	63	169		45	117	6	7,92	
219		4	3020	75	82	169	15,5	51		3	10,75	
219		5	3020	75	101	169	25	51		3	12,05	
219		6	3535	90	120	169	15,5	89		3	15,08	
219		8	3535	90	158	169	34,5	89		3	17,25	
224		231	1	2012	50	25	181	3,5	32	106	7	5,25
	231	2	2517	60	44	181		45	125	7	7,75	
	231	3	2517	60	63	181		45	125	6	8,96	
	231	4	3020	75	82	181	15,5	51		3	12,26	
	231	5	3020	75	101	181	25	51		3	13,57	
	231	6	3535	90	120	181	15,5	89		3	17,8	
	231	8	3535	90	158	181	34,5	89		3	19,8	
	231	10	3535	90	196	181	53,5	89		3	32,37	
	236	243	1	2012	50	25	193	3,5	32	104	7	5,6
		243	2	2517	60	44	193		45	117	7	8,3
243		3	2517	60	63	193		45	117	6	9,67	
243		4	3020	75	82	193	15,5	51		3	13,01	
243		5	3535	90	101	193	6	89		3	16,15	
243		6	3535	90	120	193	15,5	89		3	20,75	
243		8	3535	90	158	193	34,5	89		3	23	
243		10	3535	90	196	197	53,5	89		3	25,4	
250		257	1	2012	50	25	207	3,5	32	104	7	6,2
		257	2	2517	60	44	207		45	125	7	8,5
	257	3	3020	75	63	207		51	144	6	11,1	
	257	4	3020	75	82	207	15,5	51	144	6	12,43	
	257	5	3535	90	101	207	6	89		3	22,66	
	257	6	3535	90	120	207	15,5	89		3	24,11	
	257	8	3535	90	158	207	34,5	89		3	26,44	
	257	10	3535	90	196	207	53,5	89		3	28,72	

POLEAS TRAPECIALES PARA TAPER

V-belt taper bored pulleys

Poulies trapézoïdales pour moyeu amovible

SPB/XPB/B

dp	de	Canales Grooves / Gorges	Taper	Ø max.	F	J	S	L	Dm	Fig.	Kg.	
280	287	1	2012	50	25	237	3,5	32	104	7	6,68	
	287	2	2517	60	44	237		45	125	7	10	
	287	3	3020	75	63	237	6	51	144	6	13,33	
	287	4	3020	75	82	237	15,5	51	144	6	13,94	
	287	5	3535	90	101	237	6	89	175	6	22,85	
	287	6	3535	90	120	237	15,5	89	175	6	24,5	
	287	8	3535	90	158	237	34,5	89	175	6	26,5	
	287	10	3535	90	196	237	53,5	89	175	6	29,5	
300	307	1	2012	50	25	258	3,5	32	104	7	7,99	
	307	2	2517	60	44	257		45	125	7	11,5	
	307	3	3020	75	63	257	6	51	144	6	13,7	
	307	4	3535	90	82	257		89	175	7	19,5	
	307	5	3535	90	101	257	6	89	175	6	22,2	
	307	6	3535	90	120	257	15,5	89	175	6	24,91	
	307	8	3535	90	158	257	34,5	89	175	6	28,64	
	307	10	3535	90	196	257	53,5	89	175	6	31,5	
315	322	1	2012	50	25	272	3,5	32	104	7	7,72	
	322	2	2517	60	44	272		45	125	7	12,17	
	322	3	3020	75	63	272	6	51	144	6	11,13	
	322	4	3535	90	82	272	3,5	89	175	7	20,22	
	322	5	3535	90	101	272	6	89	175	6	23,3	
	322	6	3535	90	120	272	15,5	89	175	6	32,8	
	322	8	3535	90	158	272	34,5	89	175	6	30,45	
	322	10	3535	90	196	272	53,5	89	175	6	36,66	
	335	342	2	2517	60	44	292	3,5	45	125	7	15,25
		342	3	3020	75	63	292	6	51	144	6	16,1
342		4	3535	90	82	292	3,5	89	175	7	23,4	
342		5	3535	90	101	292	6	89	175	6	24,8	
342		6	3535	90	120	292	15,5	89	175	6	28,19	
342		8	3535	90	158	292	34,5	89	175	6	33,52	
342		10	4040	100	196	212	47	102	210	7	40,6	
355		362	2	3020	75	44	312	3,5	51	144	6	15,12
	362	3	3020	75	63	312	6	51	144	7	17,5	
	362	4	3535	90	82	312	3,5	89	175	7	23,13	
	362	5	3535	90	101	312	6	89	175	6	27,1	
	362	6	3535	90	120	312	15,5	89	175	6	28,05	
	362	8	3535	90	158	312	34,5	89	175	6	35,25	
	362	10	4040	100	196	310	47	102	210	6	47,9	
400	407	2	3020	75	44	357	3,5	51	150	4	16,07	
	407	3	3535	90	63	357	13	89	175	4	19,12	
	407	4	3535	90	82	357	3,5	89	175	4	21,97	
	407	5	3535	90	101	357	6	89	175	5	30,25	
	407	6	3535	90	120	357	15,5	89	175	5	28,31	
	407	8	4040	100	158	357	28	102	210	6	49,15	
	407	10	4040	100	196	357	47	102	210	6	54,62	
450	457	2	3020	75	44	407	3,5	51	150	4	18,25	
	457	3	3535	90	63	407		89	175	4	22,39	
	457	4	3535	90	82	407		89	175	4	32,05	
	457	5	3535	90	101	407		89	175	5	29,2	
	457	6	4040	100	120	407		102	210	5	43,2	
	457	8	4040	100	158	407	28	102	210	5	58,76	
	457	10	4545	110	196	407	41	114	242	5	63,79	
500	507	2	3020	75	44	457	3,5	51	150	4	13,67	
	507	3	3535	90	63	457		89	175	4	30,2	
	507	4	3535	90	82	457		89	175	4	27,89	
	507	5	3535	90	101	457		89	175	5	33,09	
	507	6	4040	100	120	457,0		102	210	5	48,25	
	507	8	4040	100	158	457,0	28	102	210	5	56,45	
	507	10	4545	110	196	457,0	41	114	242	5	72,49	
	560	567	2	3030	75	44	517,0	4	76	150	4	25,53
		567	3	3535	90	63	517,0		89	175	4	37,7
		567	4	3535	90	82	517,0		89	175	4	42,3
567		5	4040	100	101	517,0		102	210	4	47,54	
567		6	4040	100	120	517,0		102	210	5	51,08	
567		8	4545	110	158	517,0	22	114	242	5	69,54	
567		10	4545	110	196	517,0	41	114	242	5	78,86	
630		637	2	3030	75	44	587,0	16	76	150	4	28,53
	637	3	3535	90	63	587,0		89	175	4	41,23	
	637	4	3535	90	82	587,0		89	175	4	43,57	
	637	5	4040	100	101	587,0		102	210	4	53,59	
	637	6	4040	100	120	587,0		102	210	5	66,82	
	637	8	4545	110	158	587,0	22	114	242	5	84,45	
	637	10	4545	110	196	587,0	41	114	242	5	93,86	
	710	717	3	3535	90	63	664,0	13	89	175	4	52,61
		717	4	3535	90	82	664,0	3,5	89	175	4	60,21
		717	5	4040	100	101	664,0		102	210	4	71,22
717		6	4545	110	120	664,0	9	102	210	5	86	
717		8	4545	110	158	664,0	22	114	242	5	101,69	
717		10	4545	110	196	664,0	41	114	242	5	109,56	
800	807	3	3535	90	63	754,0	13	89	175	4	59,36	
	807	4	4040	100	82	754,0	10	102	210	4	74,42	
	807	5	4040	100	101	754,0		102	210	4	80,28	
	807	6	4545	110	120	754,0	3	114	242	5	96,48	
	807	8	4545	110	158	754,0	22	114	242	5	114,81	
	807	10	4545	110	196	754,0	41	114	242	5	129,18	
900	907	3	3535	90	63	854,0	13	89	175	4	66,47	
	907	4	4040	100	82	854,0	10	102	210	4	77,58	
	907	5	4040	100	101	854,0		102	210	4	94,53	
	907	6	4545	110	120	854,0	3	114	242	5	100,92	
	907	8	4545	110	158	854,0	22	114	242	5	117,25	
1000	1007	3	4040	100	63	954,0	19,5	102	210	4	84,89	
	1007	4	4040	100	82	954,0	10	102	210	4	91,63	
	1007	5	4545	110	101	954,0	6,5	114	242	4	111,03	
	1007	6	4545	110	120	954,0	3	114	242	5	122,01	
	1007	8	5050	125	158	954,0	15,5	127	267	5	148,52	
	1007	10	5050	125	196	954,0	34,5	127	267	5	182,62	
	1250	1257	3	4040	100	63	1204,0	19,5	102	210	4	109,95
1257		4	4545	110	82	1204,0	16	114	210	4	131,16	
1257		5	4545	110	101	1204,0	6,5	114	242	4	145,7	
1257		6	4545	110	120	1204,0	3	114	242	5	168,64	
1257		8	5050	125	158	1204,0	15,5	127	267	5	191,77	

POLEAS TRAPECIALES PARA TAPER

V-belt taper bored pulleys

Poulies trapézoïdales pour moyeu amovible

SPC/XPC/C

dp	de	Canales Grooves / Gorges	Taper	Ø max.	F	J	S	L	Dm	Fig.	Kg.
200	209,6	3	2517	60	85	144	20	45		3	10,5
	209,6	4	3020	75	111	144	30	51		3	11,31
	209,6	5	3535	90	136	144	23,5	89		3	13,47
	209,6	6	3535	90	162	144	36,5	89		3	15,4
	209,6	8	3535	90	213	144	62	89		3	19,2
212	221,6	3	3020	75	85	156	17	51		3	11,01
	221,6	4	3020	75	111	156	30	51		3	13,05
	221,6	5	3535	90	136	156	23,5	89		3	16
	221,6	6	3535	90	162	156	36,5	89		3	24,53
224	233,6	3	3020	75	85	168	17	51		3	12,37
	233,6	4	3535	75	111	168	11	89		3	16,5
	233,6	5	3535	90	136	168	23,5	89		3	18,36
	233,6	6	3535	90	162	168	36,5	89		3	20,26
236	245,6	3	3020	75	85	180	17	51		3	14,35
	245,6	4	3535	90	111	180	11	89		3	19,21
	245,6	5	3535	90	136	180	23,5	89		3	21,27
	245,6	6	3535	90	162	180	36,5	89		3	29,21
250	259,6	3	3020	75	85	194	17	51		3	16,5
	259,6	4	3535	90	111	194	11	89		3	22,5
	259,6	5	3535	90	136	194	23,5	89		3	24,75
	259,6	6	3535	90	162	194	36,5	89		3	29,29
	259,6	8	3535	90	213	194	62	89		3	31,4
	259,6	10	4040	100	264	194	81	102		3	35,91
265	274,6	3	3535	90	85	209		89	175	1	29,59
	274,6	4	3535	90	111	209	11	89		3	26,42
	274,6	5	3535	90	136	209	23,5	89		3	30,18
	274,6	6	3535	90	162	209	36,6	89		3	31,69
	274,6	8	3535	90	213	209	62	89		3	36,15
280	289,6	3	3535	90	85	224		89	175	1	27,25
	289,6	4	3535	90	111	224	11	89	175	6	27,4
	289,6	5	3535	90	136	224	23,5	89		3	32,81
	289,6	6	3535	90	162	224	36,5	89	175	6	26,25
	289,6	8	3535	90	213	224	62	89		3	40,56
	289,6	10	4040	100	264	224	8	102		3	43,39

dp	de	Canales Grooves / Gorges	Taper	Ø max.	F	J	S	L	Dm	Fig.	Kg.
300	309,6	3	3535	90	85	242	2	89	175	7	20,76
	309,6	4	3535	90	111	242	11	89	175	6	23,87
	309,6	5	3535	90	136	242	23,5	89	175	6	27
	309,6	6	3535	90	162	242	36,5	89	175	6	29,39
	309,6	8	4040	100	213	242	55,5	102		3	47,85
	309,6	10	4545	110	264	242	75	114		3	54,25
315	324,6	3	3535	90	85	259	2	89	175	7	21,91
	324,6	4	3535	90	111	259	11	89	175	6	24,34
	324,6	5	3535	90	136	259	23,5	89	175	6	28,3
	324,6	6	3535	90	162	259	36,5	89	175	6	31,05
	324,6	8	4040	100	213	259	55,5	102		3	53,5
	324,6	10	4545	110	264	259	75	114		3	60,83
335	344,6	3	3535	90	85	279	2	89	175	7	23,84
	344,6	4	3535	90	111	279	11	89	175	6	26,99
	344,6	5	3535	90	136	279	23,5	89	175	6	31
	344,6	6	3535	90	162	279	36,5	89	175	6	34,17
	344,6	8	4040	100	213	279	55,5	102	210	6	44,58
355	364,6	3	3535	90	85	299	2	89	175	7	25,61
	364,6	4	3535	90	111	299	11	89	175	6	30,65
	364,6	5	3535	90	136	299	23,5	89	175	6	34,3
	364,6	6	3535	90	162	299	36,5	89	175	6	36,87
	364,6	8	4040	110	213	299	55,5	102	210	6	45,3
	364,6	10	4545	110	264	299	75	114		3	68,77
375	384,6	3	3535	90	85	319	2	89	175	7	27,88
	384,6	4	3535	90	111	319	11	89	175	6	31,86
	384,6	5	3535	90	136	319	23,5	89	175	6	35,28
	384,6	6	4040	100	162	319	30	102	210	6	41,74
	384,6	8	4545	110	213	319	49,5	114	242	6	55,36
400	409,6	3	3535	90	85	344	2	89	175	7	31,5
	409,6	4	3535	90	111	344	11	89	175	6	35,7
	409,6	5	3535	90	136	344	23,5	89	175	6	37,99
	409,6	6	4040	100	162	344	30	102	210	6	46,8
	409,6	8	4545	110	213	344	49,5	114	242	6	59,25
409,6	10	5050	125	264	344	68,5	127	267	6	86,11	

POLEAS TRAPECIALES PARA TAPER

V-belt taper bored pulleys

Poulies trapézoïdales pour moyeu amovible

SPC/XPC/C

dp	de	Canales Grooves / Gorges	Taper	Ø max.	F	J	S	L	Dm	Fig.	Kg.
425	434,6	3	3535	90	85	369	2	89	175	7	34,77
	434,6	4	3535	90	111	369	11	89	175	6	39,36
	434,6	5	3535	90	136	369	23,5	89	175	6	44,42
	434,6	6	4040	100	162	369	30	102	210	6	52,22
	434,6	8	4545	110	213	369	49,5	114	240	6	71,87
450	459,6	3	3535	90	85	394	2	89	175	4	35,35
	459,6	4	3535	90	111	394	11	89	175	5	42,17
	459,6	5	4040	100	136	394	17	102	210	5	53,2
	459,6	6	4545	110	162	394	24	114	242	6	62,52
	459,6	8	5050	125	213	394	43	127	267	6	81,72
	459,6	10	5050	125	264	394	68,5	127	267	6	100,57
475	484,6	3	3535	90	85	419	2	89	175	4	40,65
	484,6	4	3535	90	111	419	11	89	175	5	45,95
	484,6	5	4040	100	136	419	17	102	210	5	52,79
	484,6	6	4545	110	162	419	24	114	242	6	66,64
	484,6	8	5050	125	213	419	43	127	267	6	88,81
500	509,6	3	3535	90	85	444	2,0	89	175	4	41,85
	509,6	4	3535	90	111	444	11	89	175	5	44,64
	509,6	5	4040	100	136	444	17	102	210	5	56,99
	509,6	6	4545	110	162	444	24	114	242	5	70,6
	509,6	8	5050	125	213	444	43	127	265	6	90,48
	509,6	10	5050	125	264	444	68,5	127	267	6	122,72
530	539,6	3	3535	90	85	474	2	89	175	4	46,8
	539,6	4	4040	100	111	474	4,5	102	210	5	56,14
	539,6	5	4545	110	136	474	11	114	240	5	73,85
	539,6	6	5050	125	162	474	17,5	114	265	5	85,1
	539,6	8	5050	25	213	474	43	127	267	6	99,56
560	569,6	3	3535	90	85	504	2	89	175	4	47,25
	569,6	4	4040	100	111	504	4,5	102	210	5	56,21
	569,6	5	4545	110	136	504	11	114	242	5	76,9
	569,6	6	5050	125	162	504	17,5	127	267	5	85,38
	569,6	8	5050	125	213	504	43	127	267	5	102,8
	569,6	10	5050	125	264	504	68,5	127	267	5	119,52

dp	de	Canales Grooves / Gorges	Taper	Ø max.	F	J	S	L	Dm	Fig.	Kg.
630	639,6	3	4040	100	85	574	8,5	102	210	4	56,42
	639,6	4	4545	110	111	574	1,4	114	242	4	70,81
	639,6	5	5050	125	136	574	4,5	127	267	5	89,25
	639,6	6	5050	125	162	574	17,5	127	267	5	103,30
	639,6	8	5050	125	213	574	43	127	267	5	113,82
	639,6	10	5050	125	264	574	68,5	127	267	5	130,16
	710	719,6	3	4545	100	85	652	14,5	114	242	4
719,6		4	5050	110	111	654	8	127	267	4	83,58
719,6		5	5050	125	136	654	4,5	127	267	5	101,19
719,6		6	5050	125	162	654	17,5	127	267	5	111,84
719,6		8	5050	125	213	654	43	127	267	5	128,67
719,6		10	5050	125	264	654	68,5	127	267	5	153,71
800	809,6	3	4545	110	85	737	14,5	114	242	4	93,02
	809,6	4	5050	125	111	737	8	127	267	4	109,87
	809,6	5	5050	125	136	737	4,5	127	267	5	119,84
	809,6	6	5050	125	162	737	17,5	127	267	5	140,66
	809,6	8	5050	125	213	737	43	127	267	5	160,06
	809,6	10	5050	125	264	737	68,5	127	267	5	189,00
1000	1009,6	3	5050	125	85	937	21	127	267	4	105,38
	1009,6	4	5050	125	111	937	8	127	267	4	120,63
	1009,6	5	5050	125	136	937	4,5	127	267	5	133,40
	1009,6	6	5050	125	162	937	17,5	127	267	5	157,79
	1009,6	8	5050	125	213	937	43	127	267	5	182,91
	1009,6	10	5050	125	264	937	68,5	127	267	5	251,82
1250	1259,6	3	5050	125	85	1187	21	127	267	4	148,89
	1259,6	4	5050	125	111	1187	8	127	267	4	154,37
	1259,6	5	5050	125	136	1187	4,5	127	267	5	187,92
	1259,6	6	5050	125	162	1187	17,5	127	267	5	210,52
	1259,6	8	5050	125	213	1187	43	127	267	5	251,51
	1259,6	10	5050	125	264	1187	68,5	127	267	5	287,11

POLEAS DENTADAS

Timing belt pulleys

Poulies dentées

XL 037

Paso
Pitch
Pas

1,50" (5,08 mm)

Para correas de ancho
For belt width
Pour courroies largeur

3/8" (9,52 mm)

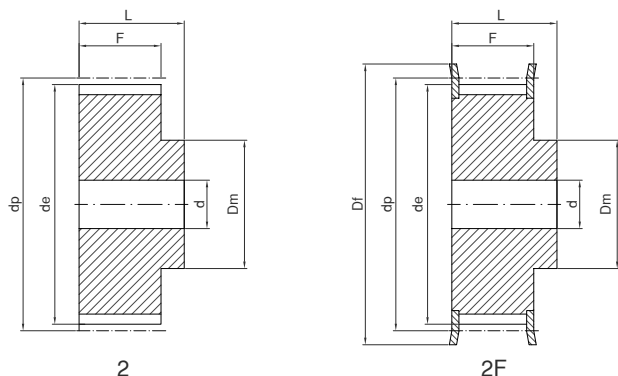

Ref.	Material	Z	dp	de	Df	Dm	F	L	d	Fig.	Kg.
10XL037	Al	10	16,17	15,66	23	10	14,3	20		2F	0,01
11XL037	Al	11	17,79	17,28	23	10	14,3	20		2F	0,01
12XL037	Al	12	19,40	18,90	25	10	14,3	20		2F	0,01
13XL037	Al	13	21,02	20,51	25	10	14,3	20		2F	0,01
14XL037	Al	14	22,64	22,13	28	16	14,3	20		2F	0,02
15XL037	Al	15	24,25	23,75	28	16	14,3	20		2F	0,02
16XL037	Al	16	25,87	25,36	32	16	14,3	20		2F	0,03
17X 037	Al	17	27,49	26,98	32	20	14,3	20		2F	0,03
18XL037	Al	18	29,11	28,60	36	20	14,3	20		2F	0,04
19XL037	Al	19	30,72	30,21	36	20	14,3	22		2F	0,04
20XL037	Al	20	32,34	31,83	38	25	14,3	22		2F	0,05
21XL037	Al	21	33,96	33,45	38	25	14,3	22		2F	0,05
22XL037	Al	22	35,57	35,07	42	25	14,3	22		2F	0,06
24XL037	Al	24	38,81	38,30	44	30	14,3	22		2F	0,06
26XL037	Al	26	42,04	41,53	48	30	14,3	22	8	2F	0,09
27XL037	Al	27	43,66	43,15	48	34	14,3	22	8	2F	0,09
28XL037	Al	28	45,28	44,77	51	34	14,3	22	8	2F	0,10
30XL037	Al	30	48,51	48,00	54	38	14,3	22	8	2F	0,12
32XL037	Al	32	51,74	51,24	57	38	14,3	25	8	2F	0,12
34XL037	Al	34	54,98	54,47	60	38	14,3	25	8	2F	0,13
35XL037	Al	35	56,60	56,09	63	38	14,3	25	8	2F	0,14
36XL037	Al	36	58,21	57,70		45	14,3	25	8	2	0,14
38XL037	Al	38	61,45	60,94		45	14,3	25	8	2	0,15
40XL037	Al	40	64,68	64,17		45	14,3	25	8	2	0,16
42XL037	Al	42	67,91	67,41		45	14,3	25	8	2	0,18
44XL037	Al	44	71,15	70,64		45	14,3	25	8	2	0,19
48XL037	Al	48	77,62	77,11		45	14,3	25	10	2	0,19
52XL037	Al	52	84,08	83,57		45	14,3	25	10	2	0,19
60XL037	Al	60	97,02	96,51		45	14,3	25	10	2	0,22
72XL037	Al	72	116,42	115,92		45	14,3	25	10	2	0,44

Material: Aluminio/Aluminium UNI 9006 - T6 (Al)



POLEAS DENTADAS

Timing belt pulleys
Poulies dentées

L 050

Paso $3/8''$ (9,525 mm)
 Pitch
Pas

Para correas de ancho $1/2''$ (12,7 mm)
 For belt width
Pour courroies largeur

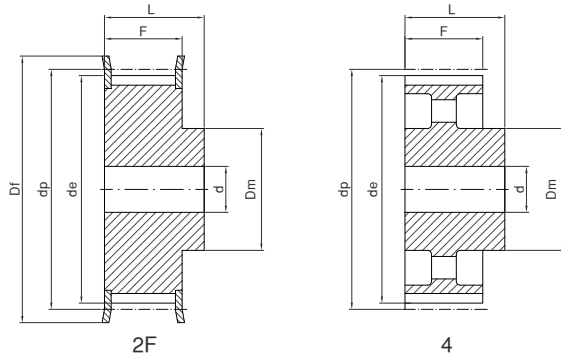

Ref.	Material	Z	dp	de	Df	Dm	F	L	d	Fig.	Kg.
10L050	St	10	30,32	29,56	36	20	19,0	28	8	2F	0,11
11L050	St	11	33,35	32,59	38	24	19,0	30	8	2F	0,14
12L050	St	12	36,38	35,62	42	24	19,0	30	8	2F	0,17
13L050	St	13	39,41	38,65	44	28	19,0	30	8	2F	0,21
14L050	St	14	42,44	41,68	48	28	19,0	30	8	2F	0,24
15L050	St	15	45,48	44,72	51	34	19,0	30	8	2F	0,29
16L050	St	16	48,51	47,75	54	36	19,0	32	8	2F	0,33
17L050	St	17	51,54	50,78	57	36	19,0	32	10	2F	0,38
18L050	St	18	54,57	53,81	60	40	19,0	32	10	2F	0,44
19L050	St	19	57,61	56,84	63	40	19,0	32	10	2F	0,47
20L050	St	20	60,64	59,88	66	40	19,0	32	10	2F	0,51
21L050	St	21	63,67	62,91	71	45	19,0	32	10	2F	0,60
22L050	St	22	66,70	65,94	75	45	19,0	32	10	2F	0,64
23L050	St	23	69,73	68,97	79	55	19,0	32	10	2F	0,78
24L050	St	24	72,77	72,00	79	55	19,0	32	10	2F	0,81
25L050	St	25	75,80	75,04	83	58	19,0	32	10	2F	0,89
26L050	St	26	78,83	78,07	87	58	19,0	32	12	2F	0,94
27L050	St	27	81,86	81,10	87	58	19,0	32	12	2F	0,99
28L050	St	28	84,89	84,13	91	58	19,0	32	12	2F	1,04
30L050	St	30	90,96	90,20	97	70	19,0	32	12	2F	1,17
32L050	St	32	97,03	96,26	103	70	19,0	32	12	2F	1,41
33L050	St	33	100,05	99,29	106	70	19,0	32	12	2F	1,49
34L050	St	34	103,08	102,32	111	70	19,0	32	12	2F	1,57
35L050	St	35	106,12	105,35	111	70	19,0	32	12	2F	1,62
36L050	St	36	109,15	108,39	115	70	19,0	32	12	2F	1,70
40L050	St	40	121,29	120,51	127	70	19,0	32	12	2F	2,03
42L050	St	42	127,34	126,58	135	70	19,0	32	12	2F	2,21
44L050	St	44	133,40	132,64	140	70	19,0	32	12	2F	2,38
45L050	St	45	136,44	135,67	143	70	19,0	32	12	2F	2,48
48L050	St	48	145,53	144,77	152	70	19,0	32	12	2F	2,78
50L050	GG	50	151,60	150,83		70	19,0	32	14	4	1,74
52L050	GG	52	157,66	156,90		70	19,0	32	14	4	1,80
56L050	GG	56	169,79	169,02		70	19,0	32	14	4	1,87
57L050	GG	57	172,82	172,06		70	19,0	32	14	4	1,88
60L050	GG	60	181,91	181,15		75	19,0	42	14	4	2,41
72L050	GG	72	218,29	217,53		75	19,0	42	14	4	2,82
84L050	GG	84	254,68	253,92		75	19,0	42	14	4	3,08
96L050	GG	96	291,06	290,30		75	19,0	42	14	4	3,42

Material: Acero/Steel/Acier (St)
 Material: Fundición/Cast iron/Fonte (GG)

POLEAS DENTADAS

Timing belt pulleys
Poulies dentées

L 075

Paso 3/8" 9,525 mm
Pitch
Pas

Para correas de ancho 3/4" (19,05 mm)
For belt width
Pour courroies largeur

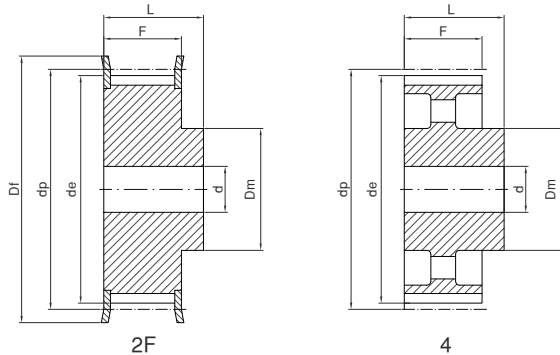

Ref.	Material	Z	dp	de	Df	Dm	F	L	d	Fig.	Kg.
10L075	St	10	30,32	29,56	36	20	25,4	38	8	2F	0,14
11L075	St	11	33,35	32,59	38	24	25,4	38	8	2F	0,18
12L075	St	12	36,38	35,62	42	24	25,4	38	8	2F	0,22
13L075	St	13	39,41	38,65	44	28	25,4	38	8	2F	0,26
14L075	St	14	42,44	41,68	48	28	25,4	38	8	2F	0,30
15L075	St	15	45,48	44,72	51	34	25,4	38	8	2F	0,37
16L075	St	16	48,51	47,75	54	36	25,4	38	8	2F	0,43
17L075	St	17	51,54	50,78	57	36	25,4	38	10	2F	0,46
18L075	St	18	54,57	53,81	60	40	25,4	38	10	2F	0,54
19L075	St	19	57,61	56,84	63	40	25,4	38	10	2F	0,58
20L075	St	20	60,64	59,88	66	40	25,4	38	10	2F	0,64
21L075	St	21	63,67	62,91	71	45	25,4	38	10	2F	0,71
22L075	St	22	66,70	65,94	75	45	25,4	38	10	2F	0,79
23L075	St	23	69,73	68,97	79	55	25,4	38	10	2F	0,94
24L075	St	24	72,77	72,00	79	55	25,4	38	10	2F	1,00
25L075	St	25	75,80	75,04	83	58	25,4	38	10	2F	1,10
26L075	St	26	78,83	78,07	87	58	25,4	38	12	2F	1,16
27L075	St	27	81,86	81,10	87	58	25,4	38	12	2F	1,22
28L075	St	28	84,89	84,13	91	58	25,4	38	12	2F	1,30
30L075	St	30	90,96	90,20	97	70	25,4	38	12	2F	1,47
32L075	St	32	97,03	96,26	103	70	25,4	38	12	2F	1,75
33L075	St	33	100,05	99,29	106	70	25,4	38	12	2F	1,85
34L075	St	34	103,08	102,32	111	70	25,4	38	12	2F	1,93
35L075	St	35	106,12	105,35	111	70	25,4	38	12	2F	2,03
36L075	St	36	109,15	108,39	115	70	25,4	38	12	2F	2,14
40L075	St	40	121,29	120,51	127	70	25,4	38	12	2F	2,56
42L075	St	42	127,34	126,58	135	70	25,4	38	12	2F	2,81
44L075	St	44	133,40	132,64	140	70	25,4	38	12	2F	3,02
45L075	St	45	136,44	135,67	143	70	25,4	38	12	2F	3,16
48L075	St	48	145,53	144,77	152	70	25,4	38	12	2F	3,57
50L075	GG	50	151,60	150,83		70	25,4	38	14	4	2,10
52L075	GG	52	157,66	156,90		70	25,4	38	14	4	2,13
56L075	GG	56	169,79	169,02		70	25,4	38	14	4	2,27
57L075	GG	57	172,82	172,06		70	25,4	38	14	4	2,28
60L075	GG	60	181,91	181,15		75	25,4	45	14	4	2,70
72L075	GG	72	218,29	217,53		75	25,4	45	14	4	3,19
84L075	GG	84	254,68	253,92		75	25,4	45	14	4	3,64
96L075	GG	96	291,06	290,30		75	25,4	45	14	4	4,04

Material: Acero/Steel/Acier (St)
Material: Fundición/Cast iron/Fonte (GG)

POLEAS DENTADAS
Timing belt pulleys
Poulies dentées

L 100

Paso 3/8" (9,525 mm)
Pitch
Pas

Para correas de ancho 1" (25,4 mm)
For belt width
Pour courroies largeur

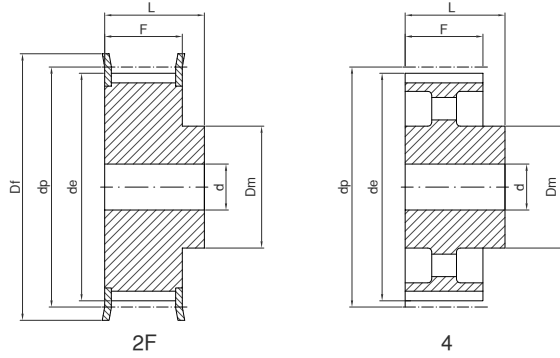

Ref.	Material	Z	dp	de	Df	Dm	F	L	d	Fig.	Kg.
10L100	St	10	30,32	29,56	36	20	31,8	45	8	2F	0,17
11L100	St	11	33,35	32,59	38	24	31,8	45	8	2F	0,22
12L100	St	12	36,38	35,62	42	24	31,8	45	8	2F	0,26
13L100	St	13	39,41	38,65	44	28	31,8	45	8	2F	0,32
14L100	St	14	42,44	41,68	48	28	31,8	45	10	2F	0,35
15L100	St	15	45,48	44,72	51	34	31,8	45	10	2F	0,43
16L100	St	16	48,51	47,75	54	36	31,8	45	10	2F	0,50
17L100	St	17	51,54	50,78	57	36	31,8	45	10	2F	0,56
18L100	St	18	54,57	53,81	60	40	31,8	45	10	2F	0,64
19L100	St	19	57,61	56,84	63	40	31,8	45	10	2F	0,70
20L100	St	20	60,64	59,88	66	40	31,8	45	10	2F	0,77
21L100	St	21	63,67	62,91	71	45	31,8	45	10	2F	0,88
22L100	St	22	66,70	65,94	75	45	31,8	45	12	2F	0,95
23L100	St	23	69,73	68,97	79	55	31,8	45	12	2F	1,11
24L100	St	24	72,77	72,00	79	55	31,8	45	12	2F	1,18
25L100	St	25	75,80	75,04	83	58	31,8	45	12	2F	1,30
26L100	St	26	78,83	78,07	87	58	31,8	45	12	2F	1,40
27L100	St	27	81,86	81,10	87	58	31,8	45	12	2F	1,47
28L100	St	28	84,89	84,13	91	58	31,8	45	12	2F	1,58
30L100	St	30	90,96	90,20	97	70	31,8	45	12	2F	1,78
32L100	St	32	97,03	96,26	103	70	31,8	45	12	2F	2,11
33L100	St	33	100,05	99,29	106	70	31,8	45	12	2F	2,23
34L100	St	34	103,08	102,32	111	70	31,8	45	12	2F	2,39
35L100	St	35	106,12	105,35	111	70	31,8	45	12	2F	2,45
36L100	St	36	109,15	108,39	115	70	31,8	45	12	2F	2,59
40L100	St	40	121,29	120,51	127	70	31,8	45	12	2F	3,13
42L100	St	42	127,34	126,58	135	70	31,8	45	12	2F	3,43
44L100	St	44	133,40	132,64	140	70	31,8	45	12	2F	3,72
45L100	St	45	136,44	135,67	143	70	31,8	45	12	2F	3,89
48L100	St	48	145,53	144,77	152	70	31,8	45	12	2F	4,38
50L100	GG	50	151,60	150,83		70	31,8	45	14	4	2,41
52L100	GG	52	157,66	156,90		70	31,8	45	14	4	2,55
56L100	GG	56	169,79	169,02		70	31,8	45	14	4	2,65
57L100	GG	57	172,82	172,06		70	31,8	45	14	4	2,71
60L100	GG	60	181,91	181,15		75	31,8	45	14	4	3,11
72L100	GG	72	218,29	217,53		75	31,8	45	14	4	3,65
84L100	GG	84	254,68	253,92		75	31,8	45	14	4	4,12
96L100	GG	96	291,06	290,30		75	31,8	45	14	4	4,60

Material: Acero/Steel/Acier (St)
Material: Fundición/Cast iron/Fonte (GG)

POLEAS DENTADAS

Timing belt pulleys

Poulies dentées

H 075

Paso Pitch
Pitch
Pas

1/2" (12,7 mm)

Para correas de ancho For belt width
For belt width
Pour courroies largeur

3/4" (19,05 mm)

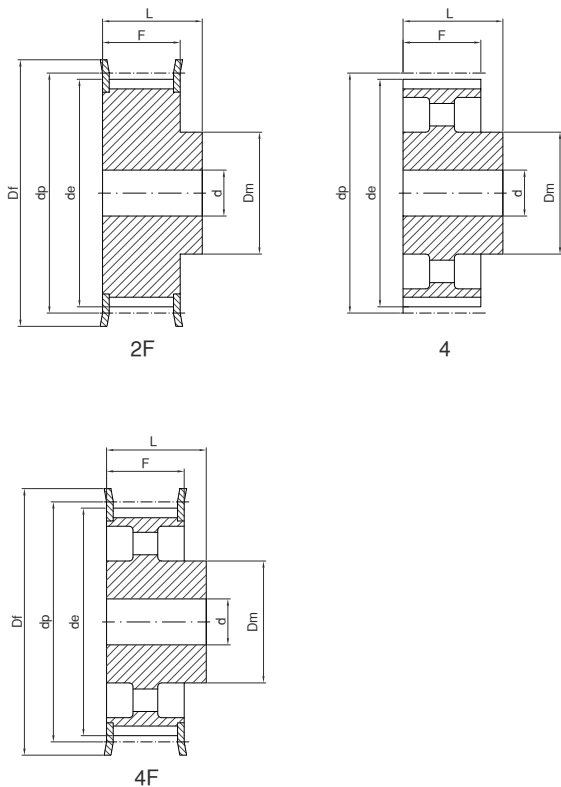

Ref.	Material	Z	dp	de	Df	Dm	F	L	d	Fig.	Kg.
14H075	St	14	56,59	55,22	63	40	26,4	40	10	2F	0,58
15H075	St	15	60,64	59,27	66	45	26,4	40	10	2F	0,69
16H075	St	16	64,68	63,31	71	45	26,4	40	10	2F	0,77
17H075	St	17	68,72	67,35	75	45	26,4	40	12	2F	0,84
18H075	St	18	72,77	71,39	79	55	26,4	40	12	2F	1,01
19H075	St	19	76,81	75,44	83	60	26,4	40	12	2F	1,15
20H075	St	20	80,85	79,48	87	62	26,4	40	12	2F	1,27
21H075	St	21	84,89	83,52	91	65	26,4	40	12	2F	1,41
22H075	St	22	88,94	87,56	93	68	26,4	40	12	2F	1,55
23H075	St	23	92,98	91,61	97	72	26,4	40	12	2F	1,71
24H075	St	24	97,03	95,65	103	72	26,4	40	12	2F	1,83
25H075	St	25	101,06	99,69	106	72	26,4	40	12	2F	1,96
26H075	St	26	105,11	103,73	111	80	26,4	40	12	2F	2,19
27H075	St	27	109,15	107,78	115	80	26,4	40	12	2F	2,32
28H075	St	28	113,19	111,82	119	80	26,4	40	12	2F	2,47
30H075	St	30	121,29	119,90	127	80	26,4	40	14	2F	2,76
32H075	St	32	129,36	127,99	135	80	26,4	40	14	2F	3,08
33H075	St	33	133,40	132,03	140	80	26,4	40	14	2F	3,25
34H075	St	34	137,45	136,07	143	80	26,4	40	14	2F	3,42
35H075	St	35	141,49	140,12	148	80	26,4	40	14	2F	3,61
36H075	St	36	145,53	144,16	152	80	26,4	40	14	2F	3,79
38H075	St	38	153,62	152,24	158	80	26,4	40	14	2F	4,16
40H075	St	40	161,70	160,33	168	80	26,4	40	14	2F	4,58
44H075	GG	44	177,87	176,50	184	80	26,4	40	18	4F	2,57
48H075	GG	48	194,04	192,67	200	90	26,4	45	18	4F	3,56
50H075	GG	50	202,13	200,75	200	90	26,4	45	18	4	3,74

POLEAS DENTADAS

Timing belt pulleys
Poulies dentées

H 100

Paso
Pitch
Pas
1/2" (12,7 mm)

Para correas de ancho
For belt width
Pour courroies largeur
1" (25,4 mm)

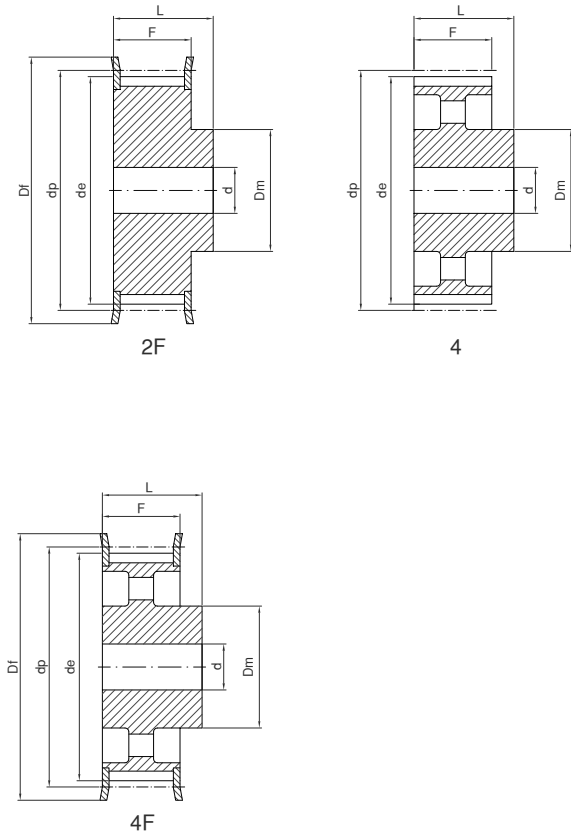

Ref.	Material	Z	dp	de	Df	Dm	F	L	d	Fig.	Kg.
14H100	St	14	56,59	55,22	63	40	31,8	45	12	2F	0,65
15H100	St	15	60,64	59,27	66	45	31,8	45	12	2F	0,77
16H100	St	16	64,68	63,31	71	45	31,8	45	12	2F	0,87
17H100	St	17	68,72	67,35	75	45	31,8	45	12	2F	0,97
18H100	St	18	72,77	71,39	79	55	31,8	45	12	2F	1,16
19H100	St	19	76,81	75,44	83	60	31,8	45	14	2F	1,30
20H100	St	20	80,85	79,48	87	62	31,8	45	14	2F	1,44
21H100	St	21	84,89	83,52	91	65	31,8	45	14	2F	1,60
22H100	St	22	88,94	87,56	93	68	31,8	45	14	2F	1,76
23H100	St	23	92,98	91,61	97	72	31,8	45	14	2F	1,94
24H100	St	24	97,03	95,65	103	72	31,8	45	14	2F	2,09
25H100	St	25	101,06	99,69	106	72	31,8	45	14	2F	2,24
26H100	St	26	105,11	103,73	111	80	31,8	45	14	2F	2,49
27H100	St	27	109,15	107,78	115	80	31,8	45	14	2F	2,66
28H100	St	28	113,19	111,82	119	80	31,8	45	14	2F	2,83
29H100	St	29	117,23	115,86	123	80	31,8	45	14	2F	3,01
30H100	St	30	121,29	119,90	127	80	31,8	45	14	2F	3,19
32H100	St	32	129,36	127,99	135	80	31,8	45	14	2F	3,57
33H100	St	33	133,40	132,03	140	80	31,8	45	14	2F	3,79
34H100	St	34	137,45	136,07	143	80	31,8	45	14	2F	3,99
35H100	St	35	141,49	140,12	148	80	31,8	45	14	2F	4,20
36H100	St	36	145,53	144,16	152	80	31,8	45	14	2F	4,44
38H100	St	38	153,62	152,24	158	80	31,8	45	14	2F	4,90
40H100	St	40	161,70	160,33	168	80	31,8	45	14	2F	5,39
44H100	GG	44	177,87	176,50	184	80	31,8	50	18	4F	3,37
45H100	GG	45	181,91	180,54	192	80	31,8	50	18	4F	3,57
48H100	GG	48	194,04	192,67	200	90	31,8	50	18	4F	4,10
50H100	GG	50	202,13	200,75		90	31,8	50	18	4	4,24
52H100	GG	52	210,21	208,84		90	31,8	50	18	4	4,32
58H100	GG	58	234,47	233,09		90	31,8	50	18	4	4,61
60H100	GG	60	242,55	241,18		100	31,8	50	18	4	5,30
70H100	GG	70	282,98	281,61		100	31,8	55	18	4	6,13
72H100	GG	72	291,06	289,69		120	31,8	55	18	4	7,47
84H100	GG	84	339,57	338,20		120	31,8	55	18	4	8,52
96H100	GG	96	388,08	386,71		120	31,8	60	18	4	10,25
120H100	GG	120	485,10	483,73		120	31,8	60	18	4	13,09

Material: Acero/Steel/Acier (St)
Material: Fundición/Cast iron/Fonete (GG)

POLEAS DENTADAS

Timing belt pulleys
Poulies dentées

H 150

Paso $1\frac{1}{2}$ " (12,7 mm)
Pitch
Pas

Para correas de ancho $1\frac{1}{2}$ " (38,1 mm)
For belt width
Pour courroies largeur

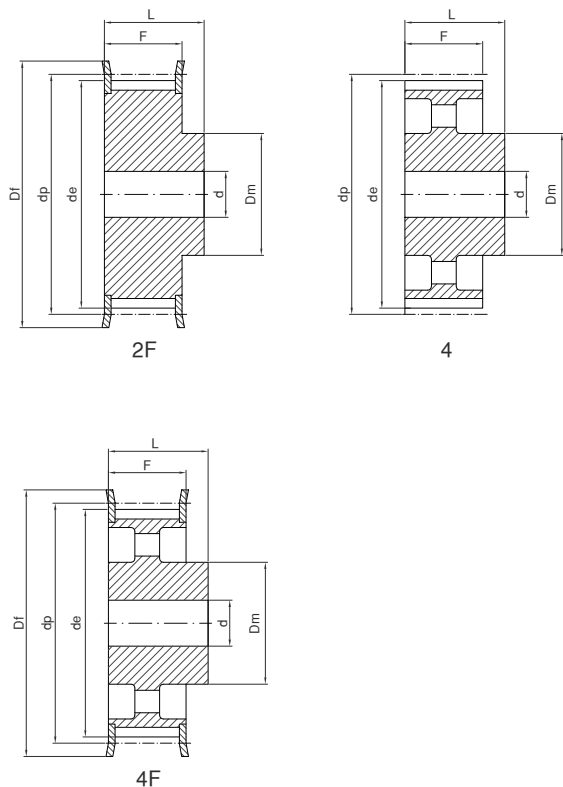

Ref.	Material	Z	dp	de	Df	Dm	F	L	d	Fig.	Kg.
14H150	St	14	56,59	55,22	63	40	46,0	58	18	2F	0,81
15H150	St	15	60,64	59,27	66	45	46,0	58	18	2F	0,97
16H150	St	16	64,68	63,31	71	45	46,0	58	18	2F	1,11
17H150	St	17	68,72	67,35	75	45	46,0	58	18	2F	1,25
18H150	St	18	72,77	71,39	79	55	46,0	58	18	2F	1,48
19H150	St	19	76,81	75,44	83	60	46,0	58	18	2F	1,68
20H150	St	20	80,85	79,48	87	62	46,0	58	18	2F	1,88
21H150	St	21	84,89	83,52	91	65	46,0	58	18	2F	2,08
22H150	St	22	88,94	87,56	93	68	46,0	58	18	2F	2,30
23H150	St	23	92,98	91,61	97	72	46,0	58	18	2F	2,54
24H150	St	24	97,03	95,65	103	72	46,0	58	18	2F	2,75
25H150	St	25	101,06	99,69	106	72	46,0	58	18	2F	2,97
26H150	St	26	105,11	103,73	111	80	46,0	58	18	2F	3,29
27H150	St	27	109,15	107,78	115	80	46,0	58	18	2F	3,52
28H150	St	28	113,19	111,82	119	80	46,0	58	18	2F	3,78
29H150	St	29	117,23	115,86	123	80	46,0	58	18	2F	4,03
30H150	St	30	121,29	119,90	127	80	46,0	58	18	2F	4,29
32H150	St	32	129,36	127,99	135	80	46,0	58	18	2F	4,86
33H150	St	33	133,40	132,03	140	80	46,0	58	18	2F	5,15
34H150	St	34	137,45	136,07	143	80	46,0	58	18	2F	5,46
35H150	St	35	141,49	140,12	148	80	46,0	58	18	2F	5,78
36H150	St	36	145,53	144,16	152	80	46,0	58	18	2F	6,09
38H150	St	38	153,62	152,24	158	80	46,0	58	18	2F	6,74
40H150	St	40	161,70	160,33	168	80	46,0	58	18	2F	7,46
44H150	GG	44	177,87	176,50	184	80	46,0	58	18	4F	4,29
45H150	GG	45	181,91	180,54	192	80	46,0	58	18	4F	4,44
48H150	GG	48	194,04	192,67	200	90	46,0	65	18	4F	5,41
50H150	GG	50	202,13	200,75		90	46,0	65	18	4	5,59
52H150	GG	52	210,21	208,84		90	46,0	65	18	4	5,79
58H150	GG	58	234,47	233,09		90	46,0	65	18	4	6,15
60H150	GG	60	242,55	241,18		100	46,0	65	18	4	7,08
70H150	GG	70	282,98	281,61		100	46,0	65	24	4	7,77
72H150	GG	72	291,06	289,69		120	46,0	65	24	4	9,70
84H150	GG	84	339,57	338,20		120	46,0	65	24	4	10,99
96H150	GG	96	388,08	386,71		120	46,0	65	24	4	12,24
120H150	GG	120	485,10	483,73		120	46,0	65	24	4	16,17

Material: Acero/Steel/Acier (St)
Material: Fundición/Cast iron/Fonte (GG)

POLEAS DENTADAS

Timing belt pulleys

Poulies dentées

H 200

Paso 1/2" (12,7 mm)
Pitch
Pas

Para correas de ancho 2" (50,8 mm)
For belt width
Pour courroies largeur

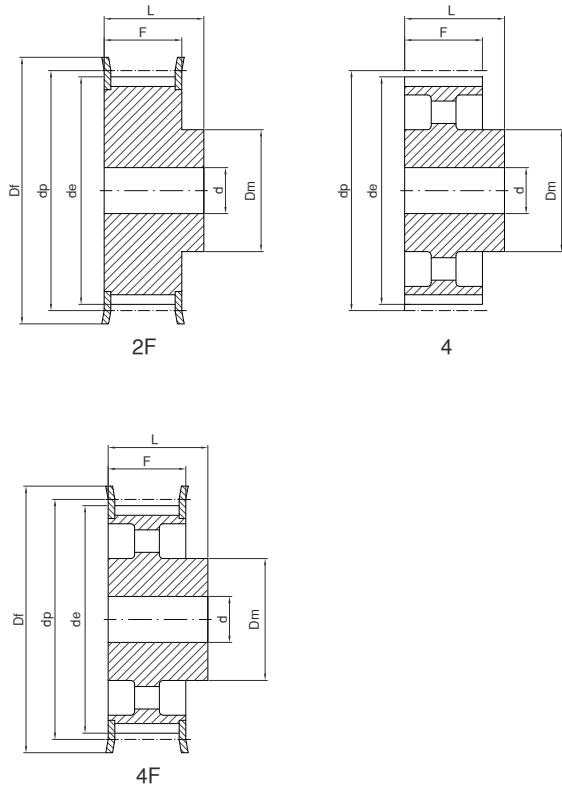

Ref.	Material	Z	dp	de	Df	Dm	F	L	d	Fig.	Kg.
14H200	St	14	56,59	55,22	63	40	58,7	70	18	2F	1,10
15H200	St	15	60,64	59,27	66	45	58,7	70	18	2F	1,33
16H200	St	16	64,68	63,31	71	45	58,7	70	18	2F	1,54
17H200	St	17	68,72	67,35	75	45	58,7	70	18	2F	1,69
18H200	St	18	72,77	71,39	79	55	58,7	70	18	2F	1,95
19H200	St	19	76,81	75,44	83	60	58,7	70	18	2F	2,20
20H200	St	20	80,85	79,48	87	62	58,7	70	18	2F	2,44
21H200	St	21	84,89	83,52	91	65	58,7	70	18	2F	2,70
22H200	St	22	88,94	87,56	93	68	58,7	70	18	2F	2,97
23H200	St	23	92,98	91,61	97	72	58,7	70	18	2F	3,25
24H200	St	24	97,03	95,65	103	72	58,7	70	18	2F	3,56
25H200	St	25	101,06	99,69	106	72	58,7	70	18	2F	3,81
26H200	St	26	105,11	103,73	111	80	58,7	70	18	2F	4,18
27H200	St	27	109,15	107,78	115	80	58,7	70	18	2F	4,49
28H200	St	28	113,19	111,82	119	80	58,7	70	18	2F	4,81
29H200	St	29	117,23	115,86	123	80	58,7	70	18	2F	5,14
30H200	St	30	121,29	119,90	127	80	58,7	70	18	2F	5,47
32H200	St	32	129,36	127,99	135	80	58,7	70	18	2F	6,17
33H200	St	33	133,40	132,03	140	80	58,7	70	18	2F	6,56
34H200	St	34	137,45	136,07	143	80	58,7	70	18	2F	6,94
35H200	St	35	141,49	140,12	148	80	58,7	70	18	2F	7,34
36H200	St	36	145,53	144,16	152	80	58,7	70	18	2F	7,75
38H200	St	38	153,62	152,24	158	80	58,7	70	18	2F	8,62
40H200	St	40	161,70	160,33	168	80	58,7	70	18	2F	9,50
44H200	GG	44	177,87	176,50	184	80	58,7	70	18	4F	5,14
45H200	GG	45	181,91	180,54	192	80	58,7	70	18	4F	5,38
48H200	GG	48	194,04	192,67	200	90	58,7	75	24	4F	6,29
50H200	GG	50	202,13	200,75		90	58,7	75	24	4	6,68
52H200	GG	52	210,21	208,84		90	58,7	75	24	4	6,81
58H200	GG	58	234,47	233,09		90	58,7	75	24	4	7,26
60H200	GG	60	242,55	241,18		100	58,7	75	24	4	8,25
70H200	GG	70	282,98	281,61		100	58,7	75	28	4	9,20
72H200	GG	72	291,06	289,69		120	58,7	75	28	4	11,09
84H200	GG	84	339,57	338,20		120	58,7	75	28	4	12,63
96H200	GG	96	388,08	386,71		120	58,7	75	28	4	14,51
120H200	GG	120	485,10	483,73		120	58,7	75	28	4	19,15

Material: Acero/Steel/Acier (St)
Material: Fundición/Cast iron/Fonte (GG)

POLEAS DENTADAS

Timing belt pulleys
Poulies dentées

H 300

Paso 1/2" (12,7 mm)
Pitch
Pas

Para correas de ancho 3" (76,2 mm)
For belt width
Pour courroies largeur

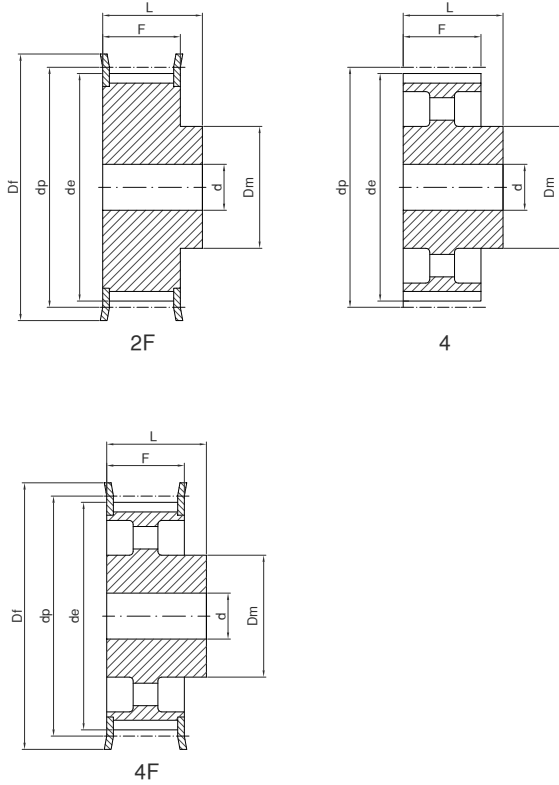

Ref.	Material	Z	dp	de	Df	Dm	F	L	d	Fig.	Kg.
14H300	St	14	56,59	55,22	63	40	85,7	100	18	2F	1,64
15H300	St	15	60,64	59,27	66	45	85,7	100	18	2F	1,91
16H300	St	16	64,68	63,31	71	45	85,7	100	18	2F	2,16
17H300	St	17	68,72	67,35	75	45	85,7	100	18	2F	2,43
18H300	St	18	72,77	71,39	79	55	85,7	100	18	2F	2,80
19H300	St	19	76,81	75,44	83	60	85,7	100	18	2F	3,16
20H300	St	20	80,85	79,48	87	62	85,7	100	18	2F	3,50
21H300	St	21	84,89	83,52	91	65	85,7	100	18	2F	3,87
22H300	St	22	88,94	87,56	93	68	85,7	100	18	2F	4,26
23H300	St	23	92,98	91,61	97	72	85,7	100	18	2F	4,68
24H300	St	24	97,03	95,65	103	72	85,7	100	18	2F	5,08
25H300	St	25	101,06	99,69	106	72	85,7	100	18	2F	5,45
26H300	St	26	105,11	103,73	111	80	85,7	100	18	2F	6,01
27H300	St	27	109,15	107,78	115	80	85,7	100	18	2F	6,45
28H300	St	28	113,19	111,82	119	80	85,7	100	18	2F	6,91
30H300	St	30	121,29	119,90	127	80	85,7	100	18	2F	7,90
32H300	St	32	129,36	127,99	135	80	85,7	100	18	2F	8,92
33H300	St	33	133,40	132,03	140	80	85,7	100	18	2F	9,46
34H300	St	34	137,45	136,07	143	80	85,7	100	18	2F	10,04
35H300	St	35	141,49	140,12	148	80	85,7	100	18	2F	10,62
36H300	St	36	145,53	144,16	152	80	85,7	100	18	2F	11,24
38H300	St	38	153,62	152,24	158	80	85,7	100	18	2F	12,44
40H300	St	40	161,70	160,33	168	80	85,7	100	18	2F	13,80
44H300	GG	44	177,87	176,50	184	80	85,7	100	24	4F	7,22
48H300	GG	48	194,04	192,67	200	90	85,7	100	24	4F	8,60
50H300	GG	50	202,13	200,75		90	85,7	100	24	4	8,99
58H300	GG	58	234,47	233,09		90	85,7	100	24	4	10,04
60H300	GG	60	242,55	241,18		100	85,7	100	24	4	11,18
72H300	GG	72	291,06	289,69		120	85,7	100	28	4	15,07
84H300	GG	84	339,57	338,20		120	85,7	100	28	4	16,97
96H300	GG	96	388,08	386,71		120	85,7	100	28	4	19,86
120H300	GG	120	485,10	483,73		120	85,7	100	28	4	25,91

Material: Acero/Steel/Acier (St)
Material: Fundición/Cast iron/Fonte (GG)

POLEAS DENTADAS PARA TAPER

Taper bored timing belt pulleys
Poulies dentées pour moyeu amovible

L 050

Paso 3/8" (9,525 mm)
Pitch
Pas

Para correas de ancho 1/2" (12,7 mm)
For belt width
Pour courroies largeur

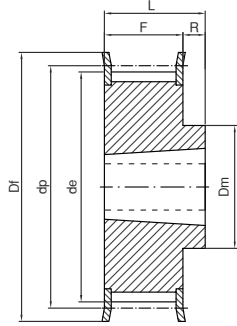

10F

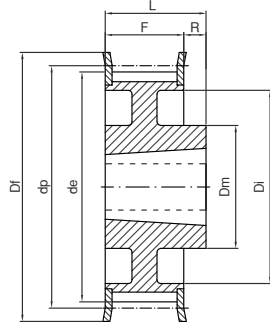

11F

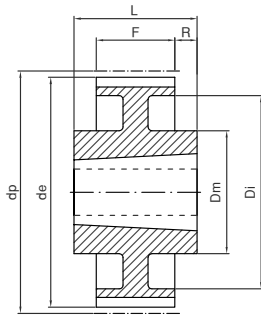

13

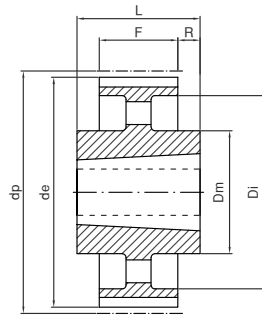

14

Ref.	Material	Z	Taper	Ø max.	dp	de	Df	Dm	Di	F	L	R	Fig.	Kg.
TL18L050	St	18	1108	28	54,57	53,81	60	45		19,0	22,0	3	10F	0,20
TL19L050	St	19	1108	28	57,61	56,84	63	45		19,0	22,0	3	10F	0,23
TL20L050	St	20	1108	28	60,64	59,88	66	48		19,0	22,0	3	10F	0,27
TL21L050	St	21	1108	28	63,67	62,91	71	48		19,0	22,0	3	10F	0,30
TL22L050	St	22	1108	28	66,70	65,94	75	51		19,0	22,0	3	10F	0,34
TL23L050	St	23	1108	28	69,73	68,97	79	54		19,0	22,0	3	10F	0,40
TL24L050	St	24	1108	28	72,77	72,00	79	54		19,0	22,0	3	10F	0,45
TL25L050	St	25	1108	28	75,80	75,04	83	56		19,0	22,0	3	10F	0,50
TL26L050	St	26	1108	28	78,83	78,07	87	60		19,0	22,0	3	10F	0,55
TL27L050	St	27	1108	28	81,86	81,10	87	62		19,0	22,0	3	10F	0,60
TL28L050	St	28	1108	28	84,89	84,13	91	65		19,0	22,0	3	10F	0,65
TL30L050	St	30	1108	28	90,96	90,20	97	70		19,0	22,0	3	10F	0,80
TL32L050	St	32	1108	28	97,02	96,26	103	74		19,0	22,0	3	10F	0,98
TL36L050	St	36	1108	28	109,15	108,39	115	85		19,0	22,0	3	10F	1,20
TL40L050	St	40	1610	42	121,28	120,51	127	97		19,0	25,0	6	10F	1,40
TL48L050	St	48	1610	42	145,53	144,77	152	88	120	19,0	25,0	6	11F	2,30
TL60L050	St	60	1610	42	181,91	181,15	92	166		19,0	25,0	3	13	2,20
TL72L050	GG	72	1610	42	218,30	217,53	92	202		19,0	25,0	3	14	2,10
TL84L050	GG	84	1610	42	254,68	253,90	92	236		19,0	25,0	3	14	2,46
TL96L050	GG	96	2012	50	291,06	290,30	106	270		19,0	32,0	6,5	14	3,36
TL120L050	GG	120	2012	50	363,83	363,07	106	343		19,0	32,0	6,5	14	4,44

Material: Acero/Steel/Acier (St)
Material: Fundición/Cast iron/Fonte (GG)

POLEAS DENTADAS PARA TAPER

Taper bored timing belt pulleys

Poulies dentées pour moyeu amovible

L 075

Paso 3/6" (9,525 mm)
Pitch
Pas

Para correas de ancho 3/4" (19,05 mm)
For belt width
Pour courroies largeur

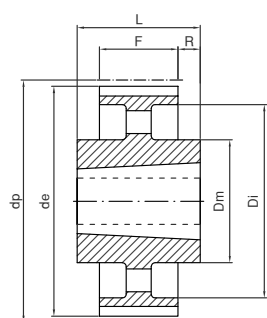

14

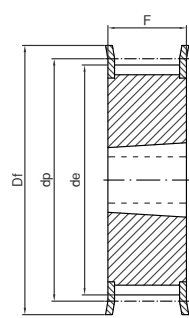

15F

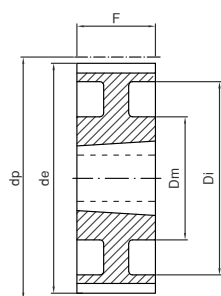

21

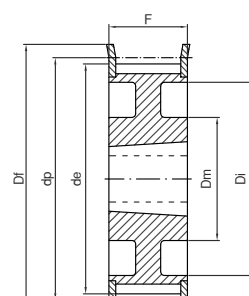

21F

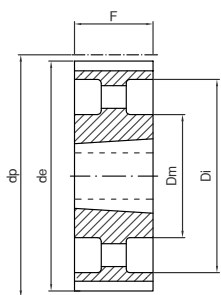

22

Ref.	Material	Z	Taper	Ø max.	dp	de	Df	Dm	Di	F	L	R	Fig.	Kg.
TL18L075	St	18	1108	28	54,57	53,81	60			25,0	25,0		15F	0,25
TL19L075	St	19	1108	28	57,61	56,84	63			25,0	25,0		15F	0,32
TL20L075	St	20	1108	28	60,64	59,88	66			25,0	25,0		15F	0,35
TL21L075	St	21	1108	28	63,67	62,91	71			25,0	25,0		15F	0,40
TL22L075	St	22	1108	28	66,70	65,94	75			25,0	25,0		15F	0,44
TL23L075	St	23	1108	28	69,73	68,97	79			25,0	25,0		15F	0,48
TL24L075	St	24	1108	28	72,77	72,00	79			25,0	25,0		15F	0,55
TL25L075	St	25	1108	28	75,80	75,04	83			25,0	25,0		15F	0,63
TL26L075	St	26	1108	28	78,83	78,07	87			25,0	25,0		15F	0,66
TL27L075	St	27	1108	28	81,86	81,10	87			25,0	25,0		15F	0,70
TL28L075	St	28	1108	28	84,89	84,13	91			25,0	25,0		15F	0,72
TL30L075	St	30	1108	28	90,96	90,20	97			25,0	25,0		15F	0,93
T 32L075	St	32	1108	28	97,02	96,26	103			25,0	25,0		15F	1,10
TL36L075	St	36	1610	42	109,15	108,39	115			25,0	25,0		15F	1,20
TL40L075	St	40	1610	42	121,28	120,51	127			25,0	25,0		15F	1,70
TL48L075	St	48	1610	42	145,53	144,77	152	92	120	25,0	25,0		21F	2,60
TL60L075	St	60	1610	42	181,91	181,15		92	166	25,0	25,0		21	3,00
TL72L075	GG	72	1610	42	218,30	217,53		92	202	25,0	25,0		22	2,33
TL84L075	GG	84	2012	50	254,68	253,90		106	236	25,0	32,0	3,5	14	3,55
TL96L075	GG	96	2012	50	291,06	290,30		106	270	25,0	32,0	3,5	14	3,95
TL120L075	GG	120	2012	50	363,83	363,07		106	343	25,0	32,0	3,5	14	5,61

Material: Acero/Steel/Acier (St)
Material: Fundición/Cast iron/Fonte (GG)

POLEAS DENTADAS PARA TAPER

Taper bored timing belt pulleys

*Poulies dentées pour moyeu amovible***L 100**Paso $3/8''$ (9,525 mm)

Pitch

*Pas*Para correas de ancho $1''$ (25,4 mm)

For belt width

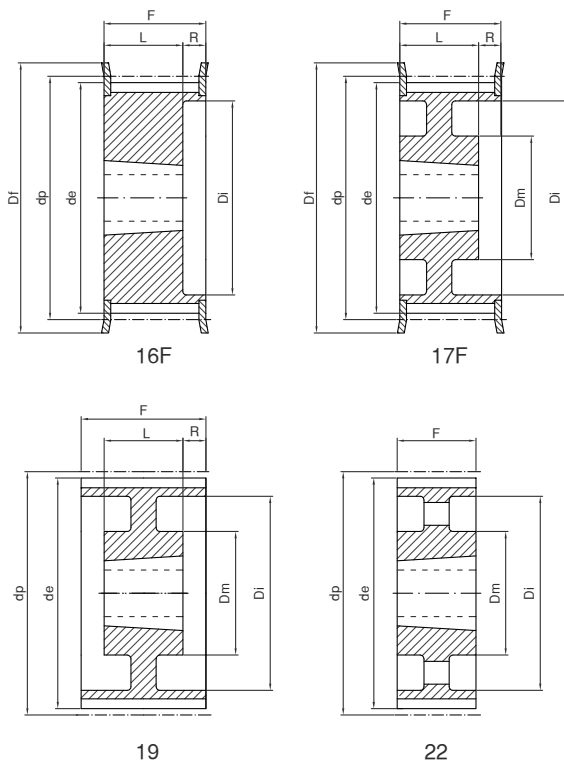
Pour courroies largeur

Ref.	Material	Z	Taper	\emptyset max.	dp	de	Df	Dm	DI	F	L	R	Fig.	Kg.
TL18L100	St	18	1108	28	54,57	53,81	60		38	31,0	22,0	9,0	16F	0,20
TL19L100	St	19	1108	28	57,61	56,84	63		38	31,0	22,0	9,0	16F	0,32
TL20L100	St	20	1108	28	60,64	59,88	66		45	31,0	22,0	9,0	16F	0,41
TL21L100	St	21	1108	28	63,67	62,91	71		45	31,0	22,0	9,0	16F	0,45
TL22L100	St	22	1108	28	66,70	65,94	75		48	31,0	22,0	9,0	16F	0,47
TL23L100	St	23	1108	28	69,73	68,97	79		52	32,0	22,0	10,0	16F	0,50
TL24L100	St	24	1108	28	72,77	72,00	79		52	32,0	22,0	10,0	16F	0,64
TL25L100	St	25	1108	28	75,80	75,04	83		54	32,0	22,0	10,0	16F	0,68
TL26L100	St	26	1108	28	78,83	78,07	87		60	32,0	22,0	10,0	16F	0,70
TL27L100	St	27	1108	28	81,86	81,10	87		60	32,0	22,0	10,0	16F	0,83
TL28L100	St	28	1108	28	84,89	84,13	91		65	32,0	22,0	10,0	16F	0,85
TL30L100	St	30	1210	32	90,96	90,20	97		71	32,0	25,0	7,0	16F	0,90
TL32L100	St	32	1210	32	97,02	96,26	103		75	32,0	25,0	7,0	16F	1,05
TL36L100	St	36	1610	42	109,15	108,39	115		86	32,0	25,0	7,0	16F	1,40
TL40L100	St	40	1610	42	121,28	120,51	127		96	32,0	25,0	7,0	16F	1,65
TL48L100	St	48	1610	42	145,53	144,77	152	92	120	32,0	25,0	7,0	17F	2,80
TL60L100	St	60	1610	42	181,91	181,15		92	166	32,0	25,0	3,5	19	2,70
TL72L100	GG	72	2012	50	218,30	217,53		106	202	32,0	32,0		22	2,96
TL84L100	GG	84	2012	50	254,68	253,90		106	236	32,0	32,0		22	3,87
TL96L100	GG	96	2012	50	291,06	290,30		106	270	32,0	32,0		22	4,64
TL120L100	GG	120	2012	50	363,83	363,07		106	343	32,0	32,0		22	6,37

Material: Acero/Steel/Acier (St)

Material: Fundición/Cast iron/Fonte (GG)

POLEAS DENTADAS PARA TAPER

Taper bored timing belt pulleys

Poulies dentées pour moyeu amovible

H 100

Paso **1/2" (12,7 mm)**

Pitch

Pas

Para correas de ancho **1" (25,4 mm)**

For belt width

Pour courroies largeur

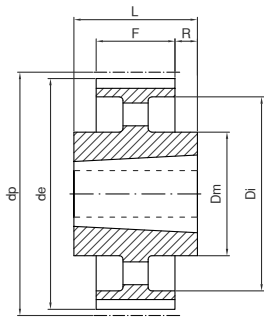

14

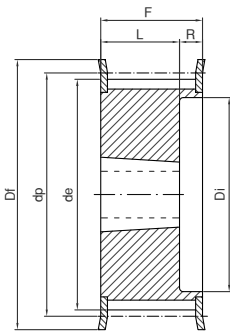

16F

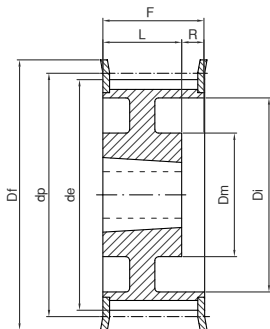

17F

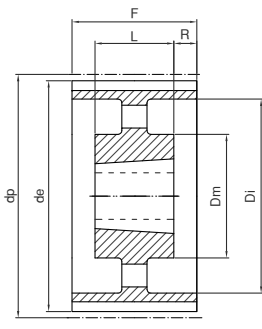

20

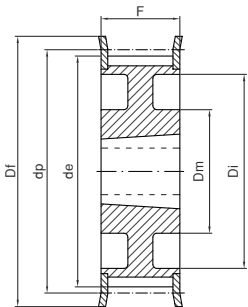

21F

Ref.	Material	Z	Taper	Ø max.	dp	de	Df	Dm	Di	F	L	R	Fig.	Kg.
TL16H100	St	16	1108	28	64,68	63,31	71		45	31,0	22,0	9,0	16F	0,42
TL18H100	St	18	1210	32	72,77	71,39	79		52	31,0	25,0	6,0	16F	0,49
TL19H100	St	19	1210	32	76,81	75,44	83		56	31,0	25,0	6,0	16F	0,62
TL20H100	St	20	1210	32	80,85	79,48	87		60	31,0	25,0	6,0	16F	0,73
TL21H100	St	21	1210	32	84,89	83,52	91		64	32,0	25,0	7,0	16F	0,80
TL22H100	St	22	1210	32	88,94	87,56	93		67	32,0	25,0	7,0	16F	0,94
TL23H100	St	23	1610	42	92,98	91,61	97		70	32,0	25,0	7,0	16F	0,97
TL24H100	St	24	1610	42	97,02	95,65	103		73,5	32,0	25,0	7,0	16F	1,05
TL25H100	St	25	1610	42	101,06	99,69	106		77	32,0	25,0	7,0	16F	1,10
TL26H100	St	26	1610	42	105,11	103,73	111		82	32,0	25,0	7,0	16F	1,20
TL27H100	St	27	1610	42	109,15	107,78	115		85	32,0	25,0	7,0	16F	1,35
TL28H100	St	28	1610	42	113,19	111,82	119		90,5	32,0	25,0	7,0	16F	1,50
TL30H100	St	30	1610	42	121,28	119,90	127		98	32,0	25,0	7,0	16F	1,78
TL32H100	St	32	1610	42	129,36	127,99	135	90	106	32,0	25,0	7,0	17F	2,05
TL36H100	St	36	1610	42	145,53	144,16	152	92	121	32,0	25,0	7,0	17F	2,80
TL40H100	St	40	1610	42	161,70	160,33	168	92	138	32,0	25,0	7,0	17F	3,65
TL44H100	St	44	2012	50	177,87	176,50	184	106	152	32,0	32,0		21F	3,86
TL48H100	St	48	2012	50	194,04	192,67	200	106	169	32,0	32,0		21F	4,20
TL60H100	GG	60	2012	50	242,55	241,18		106	223	34,0	32,0	1,0	20	3,76
TL72H100	GG	72	2012	50	291,06	289,69		106	270	34,0	32,0	1,0	20	4,88
TL84H100	GG	84	2012	50	339,57	338,20		106	318	34,0	32,0	1,0	20	6,12
TL96H100	GG	96	2517	60	388,08	386,71		119	366	34,0	45,0	5,5	14	7,95
TL120H100	GG	120	2517	60	485,10	483,73		119	462	34,0	45,0	5,5	14	10,05

Material: Acero/Steel/Acier (St)
 Material: Fundición/Cast iron/Fonte (GG)

POLEAS DENTADAS PARA TAPER

Taper bored timing belt pulleys

Poulies dentées pour moyeu amovible

H 150

Paso 1/2" (12,7 mm)
Pitch
Pas

Para correas de ancho 1" 1/2 (38,1 mm)
For belt width
Pour courroies largeur

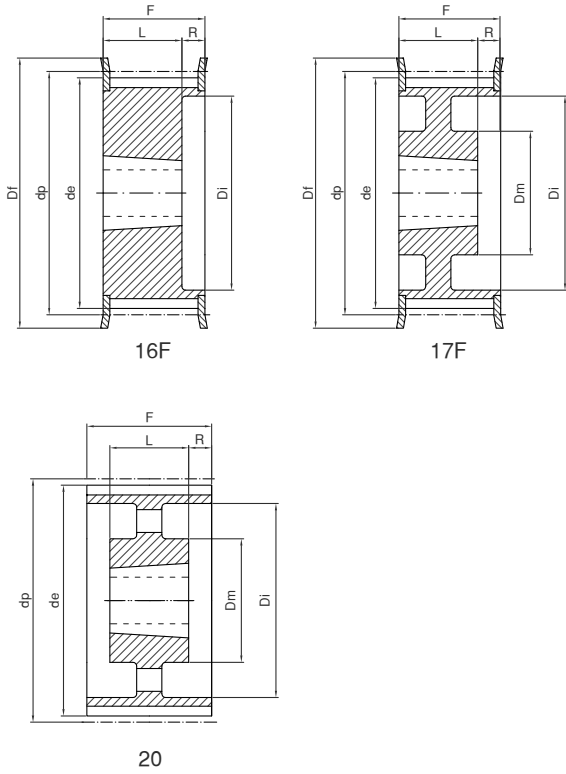

Ref.	Material	Z	Taper	Ø max.	dp	de	Df	Dm	Di	F	L	R	Fig.	Kg.
TL18H150	St	18	1210	32	72,77	71,39	79		52	45,0	25,0	20,0	16F	0,60
TL19H150	St	19	1210	32	76,81	75,44	83		56	45,0	25,0	20,0	16F	0,72
TL20H150	St	20	1210	32	80,85	79,48	87		60	45,0	25,0	20,0	16F	0,83
TL21H150	St	21	1210	32	84,89	83,52	91		64	45,0	25,0	20,0	16F	1,00
TL22H150	St	22	1210	32	88,94	87,56	93		67	45,0	25,0	20,0	16F	1,25
TL23H150	St	23	1610	42	92,98	91,61	97		70	45,0	25,0	20,0	16F	1,05
TL24H150	St	24	1610	42	97,02	95,65	103		73,5	45,0	25,0	20,0	16F	1,10
TL25H150	St	25	1610	42	101,06	99,69	106		77	45,0	25,0	20,0	16F	1,30
TL26H150	St	26	1610	42	105,11	103,73	111		82	45,0	25,0	20,0	16F	1,42
TL27H150	St	27	1610	42	109,15	107,78	115		85	45,0	25,0	20,0	16F	1,65
TL28H150	St	28	1610	42	113,19	111,82	119		90,5	45,0	25,0	20,0	16F	1,88
TL30H150	St	30	1610	42	121,28	119,90	127		98	45,0	25,0	20,0	16F	2,05
TL32H150	St	32	1610	42	129,36	127,99	135	90	106	45,0	25,0	20,0	17F	2,35
TL36H150	St	36	1610	42	145,53	144,16	152	92	121	45,0	25,0	20,0	17F	3,20
TL40H150	St	40	1610	42	161,70	160,33	168	92	138	45,0	25,0	20,0	17F	4,10
TL44H150	St	44	2012	50	177,87	176,50	184	106	152	45,0	32,0	13,0	17F	4,50
TL48H150	St	48	2012	50	194,04	192,67	200	106	169	45,0	32,0	13,0	17F	4,80
TL60H150	GG	60	2012	50	242,55	241,18		106	223	46,0	32,0	7,0	20	4,51
TL72H150	GG	72	2012	50	291,06	289,69		106	270	46,0	32,0	7,0	20	6,16
TL84H150	GG	84	2012	50	339,57	338,20		106	320	46,0	32,0	7,0	20	7,40
TL96H150	GG	96	2517	60	388,08	386,71		119	366	46,0	45,0	0,5	20	9,87
TL120H150	GG	120	2517	60	485,10	483,73		119	462	46,0	45,0	0,5	20	13,50

Material: Acero/Steel/Acier (St)
Material: Fundición/Cast iron/Fonte (GG)

POLEAS DENTADAS PARA TAPER

Taper bored timing belt pulleys

Poulies dentées pour moyeu amovible

H 200

Paso 1/2" (12,7 mm)

Pitch

Pas

Para correas de ancho 2" (50,8 mm)

For belt width

Pour courroies largeur

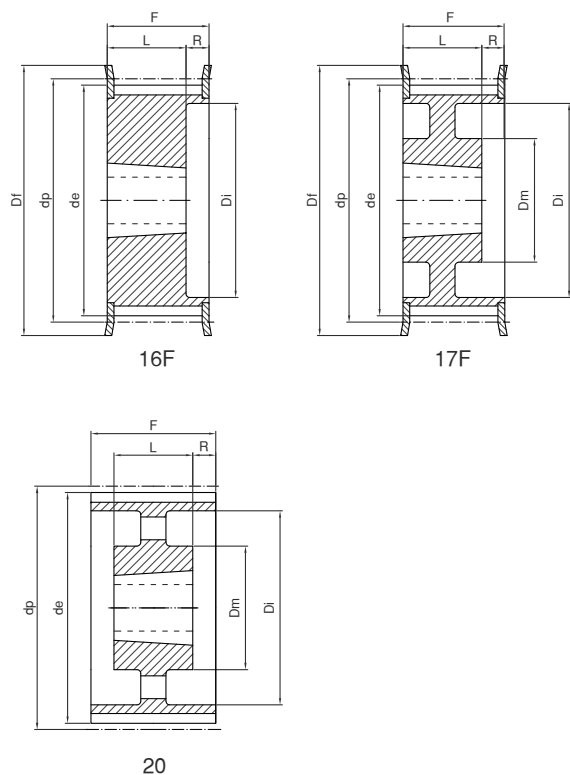

Ref.	Material	Z	Taper	Ø max.	dp	de	Df	Dm	Di	F	L	R	Fig.	Kg.
TL18H200	St	18	1210	32	72,77	71,39	79		52	58,0	25,0	33,0	16F	0,84
TL19H200	St	19	1210	32	76,81	75,44	83		56	58,0	25,0	33,0	16F	0,96
TL20H200	St	20	1610	42	80,85	79,48	87		60	58,0	25,0	33,0	16F	0,93
TL21H200	St	21	1610	42	84,89	83,52	91		64	58,0	25,0	33,0	16F	1,07
TL22H200	St	22	1610	42	88,94	87,56	93		67	58,0	25,0	33,0	16F	1,25
TL23H200	St	23	1610	42	92,98	91,61	97		70	58,0	25,0	33,0	16F	1,40
TL24H200	St	24	1610	42	97,02	95,65	103		73,5	58,0	25,0	33,0	16F	1,55
TL25H200	St	25	1610	42	101,06	99,69	106		77	58,0	25,0	33,0	16F	1,71
TL26H200	St	26	1610	42	105,11	103,73	111		82	58,0	25,0	33,0	16F	1,84
TL27H200	St	27	1610	42	109,15	107,78	115		85	58,0	25,0	33,0	16F	2,06
TL28H200	St	28	1610	42	113,19	111,82	119		90,5	58,0	25,0	33,0	16F	2,17
TL30H200	St	30	1610	42	121,28	119,90	127		98	58,0	25,0	33,0	16F	2,60
TL32H200	St	32	2012	50	129,36	127,99	135		106	58,0	32,0	26,0	16F	2,95
TL36H200	St	36	2012	50	145,53	144,16	152	102	121	58,0	32,0	26,0	17F	3,62
TL40H200	St	40	2012	50	161,70	160,33	168	106	138	58,0	32,0	26,0	17F	4,33
TL44H200	St	44	2012	50	177,87	176,50	184	106	152	58,0	32,0	26,0	17F	5,33
TL48H200	St	48	2517	60	194,04	192,67	200	119	169	58,0	45,0	13,0	17F	6,47
TL60H200	GG	60	2517	60	242,55	241,18		119	223	60,0	45,0	7,5	20	5,86
TL72H200	GG	72	2517	60	291,06	289,69		119	270	60,0	45,0	7,5	20	7,42
TL84H200	GG	84	2517	60	339,57	338,20		119	320	60,0	45,0	7,5	20	8,73
TL96H200	GG	96	2517	60	388,08	386,71		119	366	60,0	45,0	7,5	20	10,83
TL120H200	GG	120	2517	60	485,10	483,73		119	462	60,0	45,0	7,5	20	14,95

Material: Acero/Steel/Acier (St)
 Material: Fundición/Cast iron/Fonte (GG)

POLEAS DENTADAS PARA TAPER

Taper bored timing belt pulleys

*Poulies dentées pour moyeu amovible***H 300**

Paso 3/8" (9,525 mm)

Pitch

Pas

Para correas de ancho 1" (25,4 mm)

For belt width

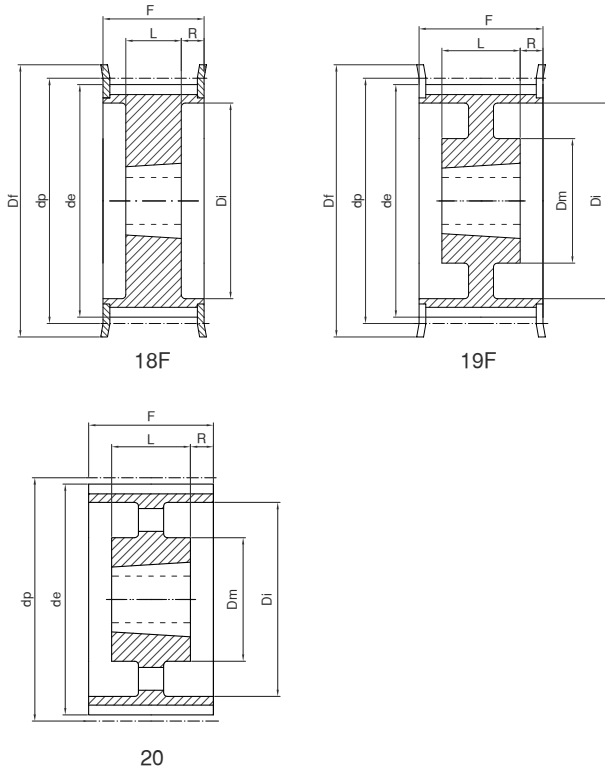
Pour courroies largeur

Ref.	Material	Z	Taper	Ø max.	dp	de	Df	Dm	Di	F	L	R	Fig.	Kg.
TL20H300	St	20	1615	42	80,85	79,48	87		64,5	84,0	38,0	23,0	18F	1,22
TL21H300	St	21	1615	42	84,89	83,52	91		65	84,0	38,0	23,0	18F	1,52
TL22H300	St	22	1615	42	88,94	87,56	93		67	84,0	38,0	23,0	18F	1,80
TL23H300	St	23	1615	42	92,98	91,61	97		70	84,0	38,0	23,0	18F	2,04
TL24H300	St	24	1615	42	97,02	95,65	103		73,5	84,0	38,0	23,0	18F	2,29
TL25H300	St	25	1615	42	101,06	99,69	106		77	84,0	38,0	23,0	18F	2,54
TL26H300	St	26	1615	42	105,11	103,73	111		82	84,0	38,0	23,0	18F	2,73
TL27H300	St	27	2012	50	109,15	107,78	115		85	84,0	32,0	26,0	18F	2,54
TL28H300	St	28	2012	50	113,19	111,82	119		90,5	84,0	32,0	26,0	18F	2,68
TL30H300	St	30	2012	50	121,28	119,90	127		98	84,0	32,0	26,0	18F	3,21
TL32H300	St	32	2517	60	129,36	127,99	135		106	84,0	45,0	19,5	18F	3,58
TL36H300	St	36	2517	60	145,53	144,16	152		121	84,0	45,0	19,5	18F	4,99
TL40H300	St	40	2517	60	161,70	160,33	168		138	84,0	45,0	19,5	18F	6,50
TL44H300	St	44	2517	60	177,87	176,50	184	119	152	86,0	45,0	20,5	19F	7,55
TL48H300	St	48	2517	60	194,04	192,67	200	119	169	86,0	45,0	20,5	19F	8,66
TL60H300	GG	60	2517	60	242,55	241,18		119	223	86,0	45,0	20,5	20	7,42
TL72H300	GG	72	2517	60	291,06	289,69		119	270	86,0	45,0	20,5	20	9,33
TL84H300	GG	84	2517	60	339,57	338,20		119	320	86,0	45,0	20,5	20	11,19
TL96H300	GG	96	3030	75	388,08	386,71		150	362	86,0	76,0	5,0	20	17,96
TL120H300	GG	120	3030	75	485,10	483,73		150	460	86,0	76,0	5,0	20	22,23

Material: Acero/Steel/Acier (St)

Material: Fundición/Cast iron/Fonete (GG)

POLEAS DENTADAS HTD

HTD timing belt pulleys

*Poulies dentées HTD***3M-09**

mm

Paso **3**
Pitch
Pas

Para correas de ancho **9**
For belt width
Pour courroies largeur

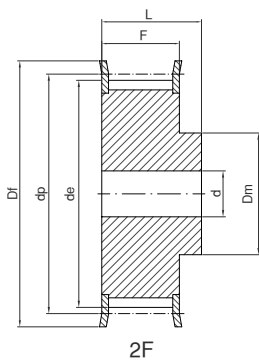
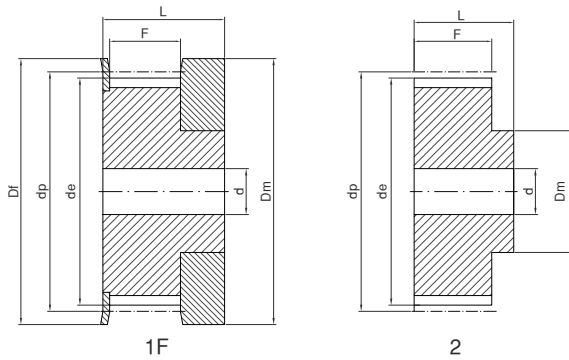

Ref.	Material	Z	dp	de	Df	Dm	F	L	d	Fig.	Kg.
103M09	Al	10	9,55	8,79	13,0	12,0	10,2	17,5		1F	0,01
123M09	Al	12	11,46	10,70	15,0	15,0	10,2	17,5		1F	0,01
143M09	Al	14	13,37	12,61	16,0	16,0	10,2	17,5		1F	0,01
153M09	Al	15	14,32	13,56	18,0	17,5	10,2	17,5		1F	0,01
163M09	Al	16	15,28	14,52	18,0	10,0	12,8	20,6	4	2F	0,01
183M09	Al	18	17,19	16,43	19,5	11,0	12,8	20,6	6	2F	0,01
203M09	Al	20	19,10	18,34	23,0	13,0	12,8	20,6	6	2F	0,01
213M09	Al	21	20,05	19,29	25,0	14,0	12,8	20,6	6	2F	0,01
223M09	Al	22	21,01	20,25	25,0	14,0	12,8	20,6	6	2F	0,01
243M09	Al	24	22,92	22,16	25,0	14,0	12,8	20,6	6	2F	0,02
263M09	Al	26	24,83	24,07	28,0	16,0	12,8	20,6	6	2F	0,02
283M09	Al	28	26,74	25,98	32,0	18,0	12,8	20,6	6	2F	0,02
303M09	Al	30	28,65	27,89	32,0	20,0	12,8	20,6	6	2F	0,03
323M09	Al	32	30,56	29,80	36,0	22,0	12,8	20,6	6	2F	0,03
363M09	Al	36	34,38	33,62	38,0	26,0	13,4	22,2	6	2F	0,05
403M09	Al	40	38,20	37,44	42,0	28,0	13,4	22,2	6	2F	0,06
443M09	Al	44	42,02	41,26	48,0	33,0	13,4	22,2	6	2F	0,07
483M09	Al	48	45,84	45,08		33,0	13,4	22,2	8	2	0,11
603M09	Al	60	57,30	56,54		33,0	13,4	22,2	8	2	0,11
723M09	Al	72	68,76	68,00		33,0	13,4	22,2	8	2	0,15

Material: Aluminio/Aluminium UNI 9006 - T6 (Al)

POLEAS DENTADAS HTD

HTD timing belt pulleys

Poulies dentées HTD

3M-09

mm

Paso

3

Pitch

Pas

Para correas de ancho

15

For belt width

Pour courroies largeur

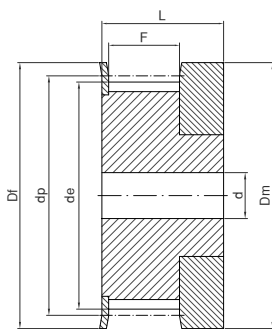

1F

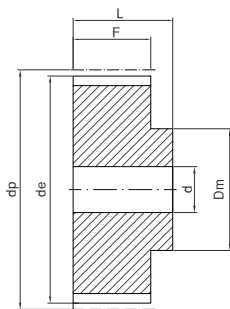

2

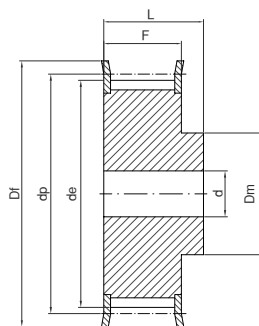

2F

Ref.	Material	Z	dp	de	Df	Dm	F	L	d	Fig.	Kg.
103M15	Al	10	9,55	8,79	13,0	12,0	17,0	26,0		1F	0,01
123M15	Al	12	11,46	10,70	15,0	15,0	17,0	26,0		1F	0,01
143M15	Al	14	13,37	12,61	16,0	16,0	17,0	26,0		1F	0,01
153M15	Al	15	14,32	13,56	18,0	17,5	17,0	26,0		1F	0,01
163M15	Al	16	15,28	14,52	18,0	10,0	19,5	26,0	4	2F	0,01
183M15	Al	18	17,19	16,43	19,5	11,0	19,5	26,0	6	2F	0,01
203M15	Al	20	19,10	18,34	23,0	13,0	19,5	26,0	6	2F	0,01
213M15	Al	21	20,05	19,29	25,0	14,0	19,5	26,0	6	2F	0,02
223M15	Al	22	21,01	20,25	25,0	14,0	19,5	26,0	6	2F	0,02
243M15	Al	24	22,92	22,16	25,0	14,0	19,5	26,0	6	2F	0,02
263M15	Al	26	24,83	24,07	28,0	16,0	19,5	26,0	6	2F	0,03
283M15	Al	28	26,74	25,98	32,0	18,0	19,5	26,0	6	2F	0,03
303M15	Al	30	28,65	27,89	32,0	20,0	19,5	26,0	6	2F	0,04
323M15	Al	32	30,56	29,80	36,0	22,0	19,5	26,0	6	2F	0,04
363M15	Al	36	34,38	33,62	38,0	26,0	20,0	30,0	6	2F	0,06
403M15	Al	40	38,20	37,44	42,0	28,0	20,0	30,0	6	2F	0,08
443M15	Al	44	42,02	41,26	48,0	33,0	20,0	30,0	6	2F	0,10
483M15	Al	48	45,84	45,08		33,0	20,0	30,0	8	2	0,10
603M15	Al	60	57,30	56,54		33,0	20,0	30,0	8	2	0,15
723M15	Al	72	68,76	68,00		33,0	20,0	30,0	8	2	0,21

Material: Aluminio/Aluminium UNI 9006 - T6 (Al)

POLEAS DENTADAS HTD

HTD timing belt pulleys

Poulies dentées HTD

5M-09

mm

Paso 5
Pitch
Pas

Para correas de ancho 9
For belt width
Pour courroies largeur

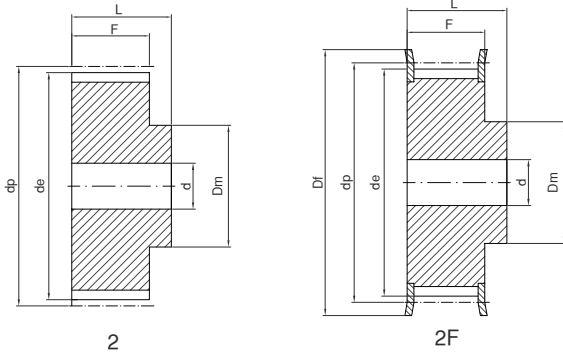

Ref.	Material	Z	dp	de	Df	Dm	F	L	d	Fig.	Kg.
125M09	St	12	19,10	17,96	23	12,5	14,5	20,0	6	2F	0,03
145M09	St	14	22,28	21,14	25	13,5	14,5	20,0	6	2F	0,04
155M09	St	15	23,87	22,73	28	16,0	14,5	20,0	6	2F	0,05
165M09	St	16	25,46	24,32	28	16,5	14,5	20,0	6	2F	0,06
185M09	St	18	28,65	27,51	32	20,0	14,5	20,0	6	2F	0,07
205M09	St	20	31,83	30,69	36	23,0	14,5	22,5	6	2F	0,10
215M09	St	21	33,42	32,28	38	24,0	14,5	22,5	6	2F	0,12
225M09	St	22	35,01	33,87	38	25,5	14,5	22,5	6	2F	0,13
245M09	St	24	38,20	37,06	42	27,0	14,5	22,5	6	2F	0,15
265M09	St	26	41,38	40,24	44	30,0	14,5	22,5	6	2F	0,18
285M09	St	28	44,56	43,42	48	30,5	14,5	22,5	6	2F	0,21
305M09	St	30	47,75	46,60	51	35,0	14,5	22,5	6	2F	0,25
325M09	St	32	50,93	49,79	54	38,0	14,5	22,5	8	2F	0,28
365M09	St	36	57,30	56,16	60	38,0	14,5	22,5	8	2F	0,33
405M09	St	40	63,66	62,52	71	38,0	14,5	22,5	8	2F	0,42
445M09	Al	44	70,03	68,89		38,0	14,5	25,5	8	2	0,17
485M09	Al	48	76,39	75,25		45,0	14,5	25,5	8	2	0,18
605M09	Al	60	95,49	94,35		45,0	14,5	25,5	8	2	0,23
725M09	Al	72	114,59	113,45		45,0	14,5	25,5	8	2	0,42

Material: Acero/Steel/Acier (St)
Material: Aluminio/Aluminium UNI 9006 - T6 (Al)

POLEAS DENTADAS HTD

HTD timing belt pulleys

Poulies dentées HTD

5M-15

mm

Paso

5

Pitch

Pas

Para correas de ancho

15

For belt width

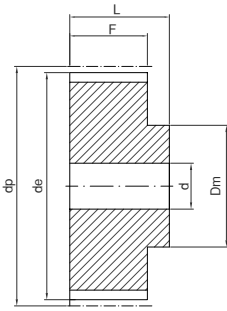
Pour courroies largeur

2

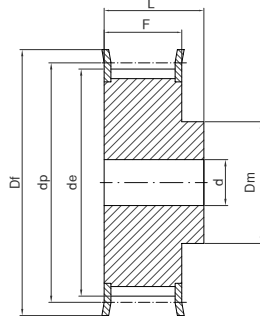

2F

Ref.	Material	Z	dp	de	Df	Dm	F	L	d	Fig.	Kg.
125M15	St	12	19,10	17,96	23	12,5	20,5	26	6	2F	0,03
145M15	St	14	22,28	21,14	25	13,5	20,5	26	6	2F	0,04
155M15	St	15	23,87	22,73	28	16,0	20,5	26	6	2F	0,05
165M15	St	16	25,46	24,32	28	16,5	20,5	26	6	2F	0,06
185M15	St	18	28,65	27,51	32	20,0	20,5	26	6	2F	0,09
205M15	St	20	31,83	30,69	36	23,0	20,5	26	6	2F	0,12
215M15	St	21	33,42	32,28	38	24,0	20,5	26	6	2F	0,14
225M15	St	22	35,01	33,87	38	25,5	20,5	26	6	2F	0,15
245M15	St	24	38,20	37,06	42	27,0	20,5	28	6	2F	0,19
265M15	St	26	41,38	40,24	44	30,0	20,5	28	6	2F	0,23
285M15	St	28	44,56	43,42	48	30,5	20,5	28	6	2F	0,26
305M15	St	30	47,75	46,60	51	35,0	20,5	28	6	2F	0,32
325M15	St	32	50,93	49,79	54	38,0	20,5	28	8	2F	0,35
365M15	St	36	57,30	56,16	60	38,0	20,5	28	8	2F	0,43
405M15	St	40	63,66	62,52	71	38,0	20,5	28	8	2F	0,52
445M15	Al	44	70,03	68,89		38,0	20,5	30	8	2	0,23
485M15	Al	48	76,39	75,25		38,0	20,5	30	8	2	0,29
605M15	Al	60	95,49	94,35		50,0	20,5	30	8	2	0,30
725M15	Al	72	114,59	113,45		50,0	20,5	30	8	2	0,59

Material: Acero/Steel/Acier (St)

Material: Aluminio/Aluminium UNI 9006 - T6 (Al)

POLEAS DENTADAS HTD

HTD timing belt pulleys
Poulies dentées HTD

5M-25

mm

Paso

5

Pitch

Pas

Para correas de ancho

25

For belt width

Pour courroies largeur

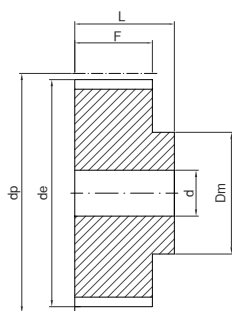

2

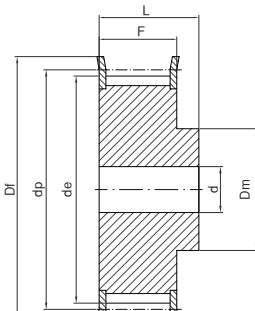

2F

Ref.	Material	Z	dp	de	Df	Dm	F	L	d	Fig.	Kg.
125M25	St	12	19,10	17,96	23	12,5	30,5	36	6	2F	0,05
145M25	St	14	22,28	21,14	25	13,5	30,5	36	6	2F	0,08
155M25	St	15	23,87	22,73	28	16,0	30,5	36	6	2F	0,09
165M25	St	16	25,46	24,32	28	16,5	30,5	36	6	2F	0,11
185M25	St	18	28,65	27,51	32	20,0	30,5	36	6	2F	0,13
205M25	St	20	31,83	30,69	36	23,0	30,5	36	6	2F	0,17
215M25	St	21	33,42	32,28	38	24,0	30,5	38	6	2F	0,20
225M25	St	22	35,01	33,87	38	25,5	30,5	38	6	2F	0,22
245M25	St	24	38,20	37,06	42	27,0	30,5	38	6	2F	0,26
265M25	St	26	41,38	40,24	44	30,0	30,5	38	6	2F	0,32
285M25	St	28	44,56	43,42	48	30,5	30,5	38	6	2F	0,37
305M25	St	30	47,75	46,60	51	35,0	30,5	38	6	2F	0,42
325M25	St	32	50,93	49,79	54	38,0	30,5	38	8	2F	0,48
365M25	St	36	57,30	56,16	60	38,0	30,5	38	8	2F	0,59
405M25	St	40	63,66	62,52	71	38,0	30,5	38	8	2F	0,75
445M25	Al	44	70,03	68,89		38,0	30,5	40	8	2	0,32
485M25	Al	48	76,39	75,25		38,0	30,5	40	8	2	0,28
605M25	Al	60	95,49	94,35		50,0	30,5	40	8	2	0,44
725M25	Al	72	114,59	113,45		50,0	30,5	40	8	2	0,85

Material: Acero/Steel/Acier (St)
Material: Aluminio/Aluminium UNI 9006 - T6 (Al)

POLEAS DENTADAS HTD

HTD timing belt pulleys

Poulies dentées HTD

8M-20

mm

Paso
Pitch
Pas 8

Para correas de ancho
For belt width
Pour courroies largeur 20

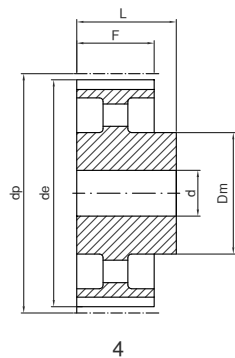
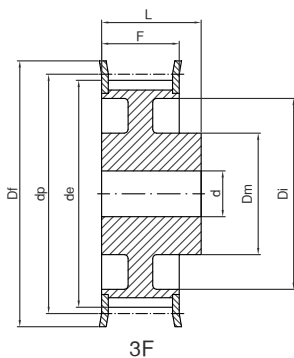
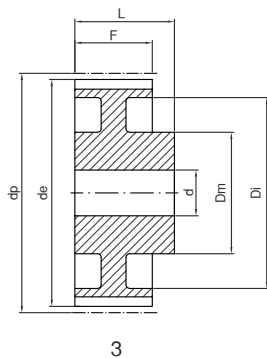
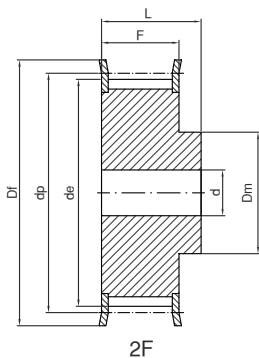

Ref.	Material	Z	dp	de	Df	Dm	Di	F	L	d	Fig.	Kg.
228M20	St	22	56,02	54,65	60	43		28	38	12	2F	0,54
248M20	St	24	61,11	59,74	66	45		28	38	12	2F	0,65
268M20	St	26	66,21	64,84	71	48		28	38	12	2F	0,80
288M20	St	28	71,30	70,08	75	50		28	38	14	2F	0,88
308M20	St	30	76,39	75,13	83	55		28	38	14	2F	1,00
328M20	St	32	81,49	80,16	87	60		28	38	14	2F	1,20
348M20	St	34	86,58	85,21	91	66		28	38	14	2F	1,40
368M20	St	36	91,67	90,30	98	70		28	38	14	2F	1,60
388M20	St	38	96,77	95,39	103	75		28	38	14	2F	1,70
408M20	St	40	101,86	100,49	106	75		28	38	14	2F	1,85
448M20	St	44	112,05	110,67	119	75		28	38	14	2F	2,10
488M20	St	48	122,23	120,86	127	75		28	38	14	2F	2,50
568M20	St	56	142,60	141,23	148	80	116	28	38	14	3F	2,82
648M20	St	64	162,97	161,60	168	80	137	28	38	14	3F	3,22
728M20	St	72	183,35	181,97	192	80	158	28	38	14	3F	3,74
808M20	GG	80	203,72	202,35		90	180	28	38	14	3	3,78
908M20	GG	90	229,18	227,81		90	204	28	38	14	3	4,57
* 1128M20	GG	112	285,21	283,83		90	254	28	38	18	4	
* 1448M20	GG	144	366,69	365,32		90	336	28	38	20	4	
* 1688M20	GG	168	427,81	426,44		100	400	28	38	20	4	
* 1928M20	GG	192	488,92	487,55		100	460	28	38	20	4	

Material: Acero/Steel/Acier (St)
Material: Fundición/Cast iron/Fonte (GG)

POLEAS DENTADAS HTD

HTD timing belt pulleys
Poulies dentées HTD

5M-25

mm

Paso
Pitch
Pas

8

Para correas de ancho
For belt width
Pour courroies largeur

30

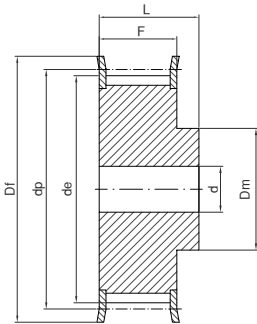

2F

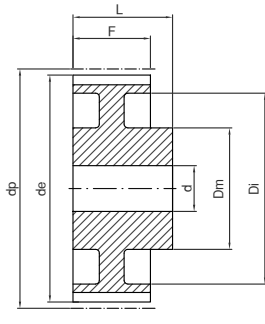

3

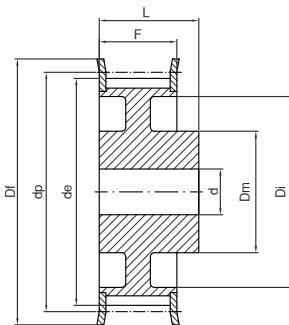

3F

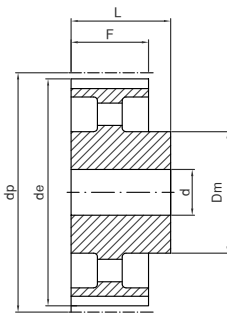

4

Ref.	Material	Z	dp	de	Df	Dm	Di	F	L	d	Fig.	Kg.
228M30	St	22	56,02	54,65	60	43		38	48	12	2F	0,75
248M30	St	24	61,11	59,74	66	45		38	48	12	2F	0,90
268M30	St	26	66,21	64,84	71	48		38	48	12	2F	1,10
288M30	St	28	71,30	70,08	75	50		38	48	14	2F	1,20
308M30	St	30	76,39	75,13	83	55		38	48	14	2F	1,32
328M30	St	32	81,49	80,16	87	60		38	48	14	2F	1,55
348M30	St	34	86,58	85,21	91	66		38	48	14	2F	1,80
368M30	St	36	91,67	90,30	98	70		38	48	14	2F	2,10
388M30	St	38	96,77	95,39	103	75		38	48	14	2F	2,30
408M30	St	40	101,86	100,49	106	75		38	48	14	2F	2,47
448M30	St	44	112,05	110,67	119	75		38	48	14	2F	2,95
488M30	St	48	122,23	120,86	127	75		38	48	14	2F	3,30
568M30	St	56	142,60	141,23	148	90	116	38	48	14	3F	4,02
648M30	St	64	162,97	161,60	168	90	137	38	48	14	3F	4,60
728M30	St	72	183,35	181,97	192	95	158	38	48	14	3F	5,41
808M30	GG	80	203,72	202,35		100	180	38	48	14	3	5,23
908M30	GG	90	229,18	227,81		100	204	38	48	14	3	6,42
1128M30	GG	112	285,21	283,83		100	254	38	48	18	4	8,12
1448M30	GG	144	366,69	365,32		100	336	38	48	20	4	10,36
1688M30	GG	168	427,81	426,44		100	400	38	48	20	4	12,37
1928M30	GG	192	488,92	487,55		100	460	38	48	20	4	14,31

Material: Acero/Steel/Acier (St)
Material: Fundición/Cast iron/Fonte (GG)

POLEAS DENTADAS HTD

HTD timing belt pulleys
Poulies dentées HTD

8M-50

mm

Paso 8
 Pitch
Pas

Para correas de ancho 50
 For belt width
Pour courroies largeur

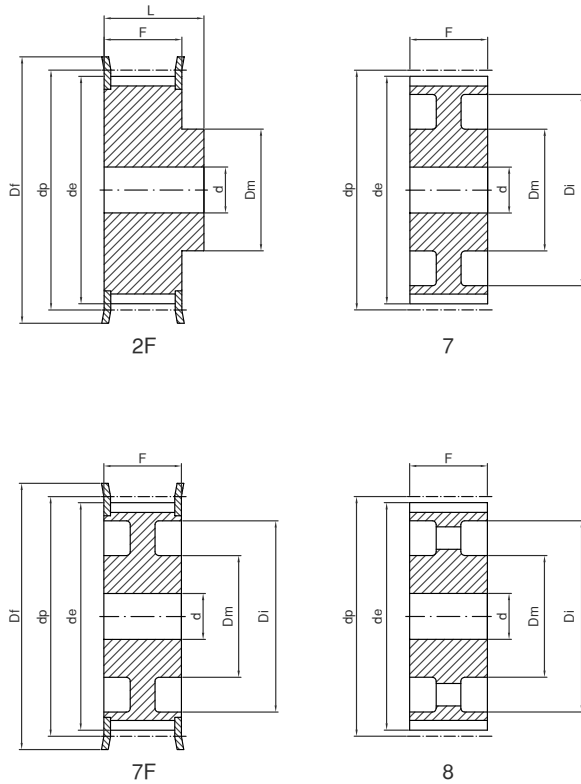

Ref.	Material	Z	dp	de	Df	Dm	Di	F	L	d	Fig.	Kg.
228M50	St	22	56,02	54,65	60	43		60	70	12	2F	1,10
248M50	St	24	61,11	59,74	66	45		60	70	12	2F	1,30
268M50	St	26	66,21	64,84	71	48		60	70	12	2F	1,60
288M50	St	28	71,30	70,08	75	50		60	70	14	2F	1,70
308M50	St	30	76,39	75,13	83	55		60	70	14	2F	2,00
328M50	St	32	81,49	80,16	87	60		60	70	14	2F	2,35
348M50	St	34	86,58	85,21	91	66		60	70	14	2F	2,80
368M50	St	36	91,67	90,30	98	70		60	70	14	2F	3,10
388M50	St	38	96,77	95,39	103	75		60	70	14	2F	3,30
408M50	St	40	101,86	100,49	106	75		60	70	14	2F	3,60
448M50	St	44	112,05	110,67	119	75		60	70	14	2F	4,40
488M50	St	48	122,23	120,86	127	75		60	70	14	2F	5,00
568M50	St	56	142,60	141,23	148	90	116	60	60	18	7F	5,68
648M50	St	64	162,97	161,60	168	100	137	60	60	18	7F	6,93
728M50	St	72	183,35	181,97	192	100	158	60	60	18	7F	7,95
808M50	GG	80	203,72	202,35		110	180	60	60	18	7	7,96
908M50	GG	90	229,18	227,81		110	204	60	60	18	7	9,20
1128M50	GG	112	285,21	283,83		110	254	60	60	18	8	12,16
1448M50	GG	144	366,69	365,32		110	336	60	60	20	8	15,68
1688M50	GG	168	427,81	426,44		120	400	60	60	20	8	18,99
1928M50	GG	192	488,92	487,55		130	460	60	60	20	8	24,09

Material: Acero/Steel/Acier (St)
 Material: Fundición/Cast iron/Fonte (GG)

POLEAS DENTADAS HTD PARA TAPER

HTD taper bored timing belt pulleys

Poulies dentées HTD pour moyeu amovible

5M-15

mm

Paso

5

Pitch

Pas

Para correas de ancho

15

For belt width

Pour courroies largeur

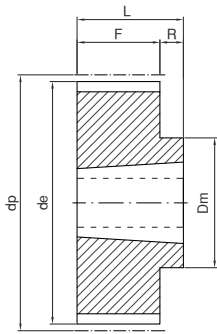

10

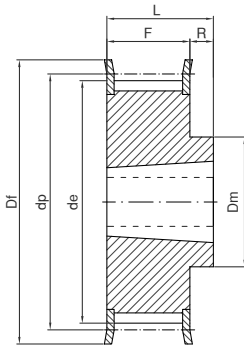

10F

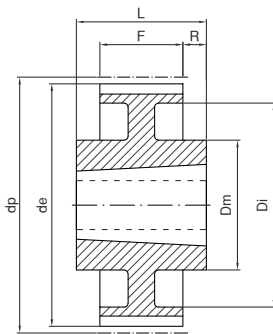

13

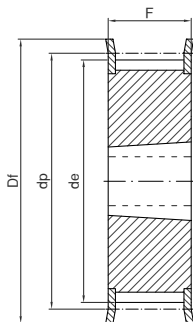

15F

Ref.	Material	Z	Taper	Ø max.	dp	de	Df	Dm	Di	F	L	R	Fig.	Kg.
TL345M15	St	34	1008	25	54,11	52,97	57	22		22			15F	0,20
TL365M15	St	36	1108	25	57,30	56,15	60	22		22			15F	0,25
TL385M15	St	38	1108	25	60,48	59,34	66	22		22			15F	0,30
TL405M15	St	40	1108	25	63,66	62,52	71	22		22			15F	0,35
TL445M15	St	44	1108	25	70,03	68,89	75	22		22			15F	0,40
TL485M15	St	48	1210	32	76,39	75,25	83	59	22		25	3	10F	0,46
TL565M15	St	56	1210	32	89,13	87,99	93	70	22		25	3	10F	0,60
TL645M15	St	64	1210	32	101,86	100,72	106	80	22		25	3	10F	0,80
TL725M15	St	72	1610	42	114,59	113,45	92	22			25	3	10	1,20
TL805M15	St	80	1610	42	127,32	126,18	92	22			25	3	10	1,76
TL905M15	St	90	1610	42	143,24	142,10	92	22			25	3	10	2,32
TL1125M15	St	112	2012	50	178,25	177,11	110			20	32	12	10	
TL1365M15	St	136	2012	50	216,45	215,31	110	199	20	32	6	13		

Material: Acero/Steel/Acier (St)

POLEAS DENTADAS HTD PARA TAPER

HTD taper bored timing belt pulleys

Poulies dentées HTD pour moyeu amovible

8M-30

mm

Paso 8
Pitch 8
Pas 8

Para correas de ancho 30
For belt width 30
Pour courroies largeur 30

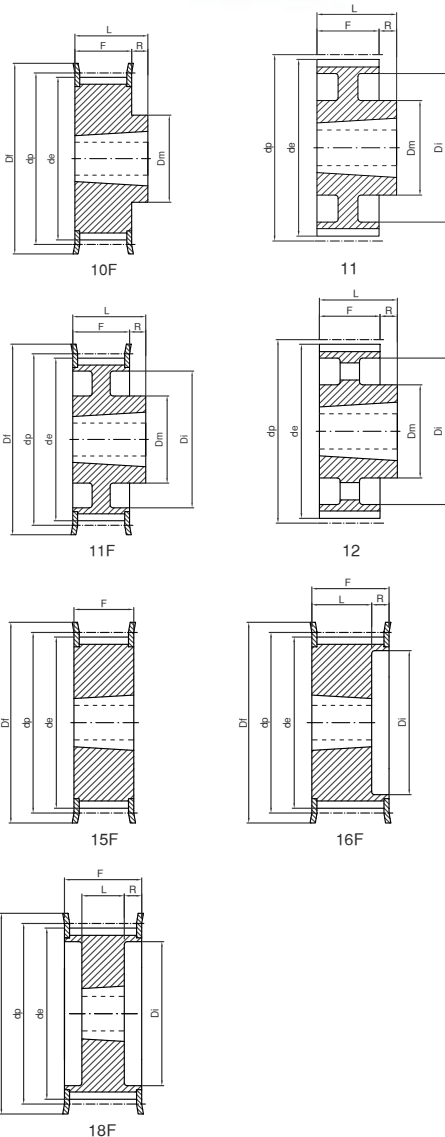

Material: Acero/Steel/Acier (St)
Material: Fundición/Cast iron/Fonte (GG)

Ref.	Material	Z	Taper	Ø max.	dp	de	Df	Dm	Di	F	L	R	Fig.	Kg.
TL228M30	St	22	1008	25	56,02	54,65	60		37	38	22	16	16F	0,33
TL248M30	St	24	1108	25	61,11	59,74	66		44	38	22	16	16F	0,40
TL268M30	St	26	1108	25	66,21	64,84	71		44	38	22	16	16F	0,45
TL288M30	St	28	1210	32	71,30	70,08	75		50	38	25	13	16F	0,50
TL308M30	St	30	1615	42	76,39	75,13	83			38	38		15F	0,55
TL328M30	St	32	1615	42	81,49	80,16	87			38	38		15F	0,60
TL348M30	St	34	1615	42	86,58	85,21	91			38	38		15F	0,80
TL368M30	St	36	1615	42	91,67	90,30	98			38	38		15F	1,00
TL388M30	St	38	1615	42	96,77	95,39	103			38	38		15F	1,10
TL408M30	St	40	1615	42	101,86	100,49	106			38	38		15F	1,34
TL448M30	St	44	2012	50	112,05	110,67	119		86	38	32	3	18F	1,30
TL488M30	St	48	2012	50	122,23	120,86	127		90	38	32	3	18F	1,80
TL568M30	St	56	2012	50	142,60	141,23	148		110	38	32	3	18F	3,80
TL648M30	St	64	2517	60	162,97	161,60	168	125		38	45	7	10F	4,30
TL728M30	St	72	2517	60	183,35	181,97	192	125	158	38	45	7	11F	4,40
TL808M30	GG	80	2517	60	203,72	202,35		125	180	38	45	7	11	4,65
TL908M30	GG	90	2517	60	229,18	227,81		125	204	38	45	7	11	5,80
TL1128M30	GG	112	2517	60	285,21	283,83		125	254	38	45	7	12	6,20
TL1448M30	GG	144	2517	60	366,69	365,32		125	336	38	45	7	12	9,00

POLEAS DENTADAS HTD PARA TAPER

HTD taper bored timing belt pulleys

Poulies dentées HTD pour moyeu amovible

8M-50

mm

Paso

8

Pitch

Pas

Para correas de ancho

50

For belt width

Pour courroies largeur

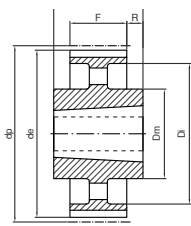

14

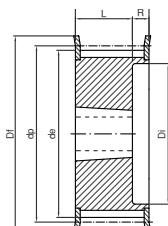

16F

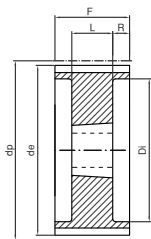

18

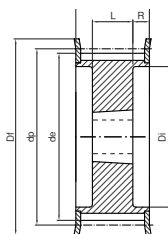

18F

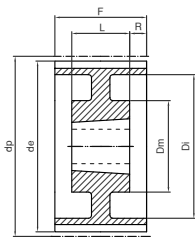

19

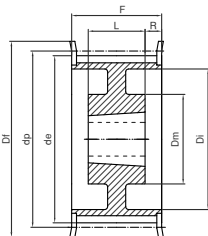

19F

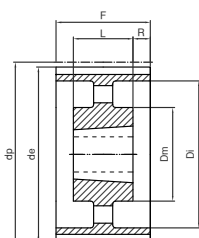

20

Ref.	Material	Z	Taper	Ø max.	dp	de	Df	Dm	Di	F	L	R	Fig.	Kg.
TL288M50	St	28	1210	32	71,30	70,08	75	50	60	25	35	16F	0,60	
TL308M50	St	30	1615	42	76,39	75,13	83	58	60	38	22	16F	0,65	
TL328M50	St	32	1615	42	81,49	80,16	87	63	60	38	22	16F	0,80	
TL348M50	St	34	1615	42	86,58	85,21	91	65	60	38	22	16F	1,08	
TL368M50	St	36	1615	42	91,67	90,30	98	68	60	38	22	16F	1,35	
TL388M50	St	38	1615	42	96,77	95,39	103	72	60	38	22	16F	1,65	
TL408M50	St	40	2012	50	101,86	100,49	106	80	60	32	14	18F	1,70	
TL448M50	St	44	2012	50	112,05	110,67	119	86	60	32	14	18F	1,80	
TL488M50	St	48	2012	50	122,23	120,86	127	95	60	32	14	18F	2,35	
TL568M50	St	56	2517	60	142,60	141,23	148	116	60	45	7,5	18F	3,35	
TL648M50	St	64	2517	60	162,97	161,60	168	136	60	45	7,5	18F	4,90	
TL728M50	St	72	2517	60	183,35	181,97	192	125	158	60	45	7,5	19F	6,90
TL808M50	GG	80	3020	75	203,72	202,35		180	60	51	4,5	18	8,90	
TL908M50	GG	90	3020	75	229,18	227,81		160	204	60	51	4,5	19	9,90
TL1128M50	GG	112	3020	75	285,21	283,83		170	254	60	51	4,5	19	12,10
TL1448M50	GG	144	3020	75	366,69	365,32		170	336	60	51	4,5	20	15,40
TL1688M50	GG	168	3525	90	427,81	426,44		198	395	60	65	2,5	14	22,80
TL1928M50	GG	192	3525	90	488,92	487,55		198	455	60	65	2,5	14	26,50

Material: Acero/Steel/Acier (St)
Material: Fundición/Cast iron/Fonte (GG)

POLEAS DENTADAS HTD PARA TAPER

HTD taper bored timing belt pulleys

Poulies dentées HTD pour moyeu amovible

8M-85

mm

Paso

8

Pitch

Pas

Para correas de ancho

85

For belt width

Pour courroies largeur

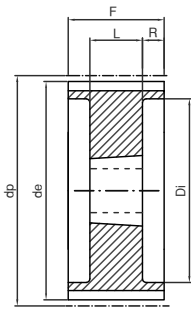

18

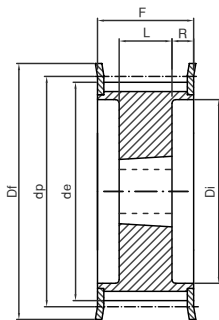

18F

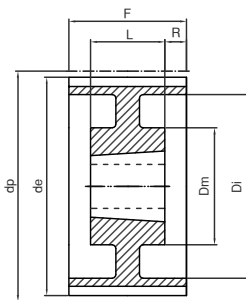

19

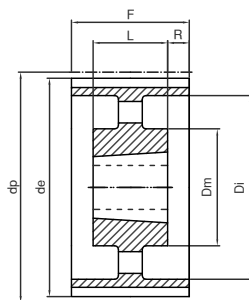

20

Ref.	Material	Z	Taper Ø max.	dp	de	Df	Dm	Di	F	L	R	Fig.	Kg.	
TL348M85	St	34	1615	42	86,58	85,22	91	65	95	38	28,5	18F	1,50	
TL368M85	St	36	1615	42	91,67	90,30	98	68	95	38	28,5	18F	1,90	
TL388M85	St	38	1615	42	96,77	95,39	103	72	95	38	28,5	18F	2,20	
TL408M85	St	40	2012	50	101,86	100,49	106	80	95	32	31,5	18F	1,90	
TL448M85	St	44	2012	50	112,05	110,67	119	86	95	32	31,5	18F	2,30	
TL488M85	St	48	2517	60	122,23	120,86	127	97	95	45	25	18F	2,70	
TL568M85	St	56	2517	60	142,60	141,23	148	116	95	45	25	18F	4,50	
TL648M85	St	64	2517	60	162,97	161,60	168	136	95	45	25	18F	6,30	
TL728M85	St	72	3020	75	183,35	181,97	192	150	95	51	22	18F	8,10	
TL808M85	GG	80	3020	75	203,72	202,35		180	95	51	22	18	10,20	
TL908M85	GG	90	3020	75	229,18	227,81		170	204	95	51	22	19	11,20
TL1128M85	GG	112	3020	75	285,21	283,83		170	254	95	51	22	19	15,00
TL1448M85	GG	144	3525	90	366,69	365,32		198	336	95	65	15	20	20,20
TL1688M85	GG	168	3525	90	427,81	426,44		198	395	95	65	15	20	22,40
TL1928M85	GG	192	3525	90	488,92	487,55		198	455	95	65	15	20	28,20

Material: Acero/Steel/Acier (St)

Material: Fundición/Cast iron/Fonete (GG)

POLEAS DENTADAS HTD PARA TAPER

HTD taper bored timing belt pulleys

Poulies dentées HTD pour moyeu amovible

14M-40

mm

Paso

14

Pitch

Pas

Para correas de ancho

40

For belt width

Pour courroies largeur

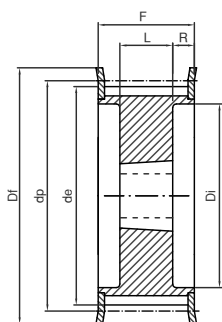

18F

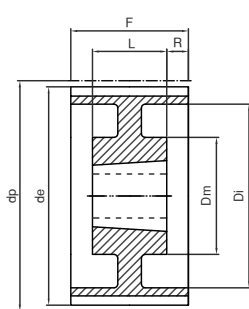

19

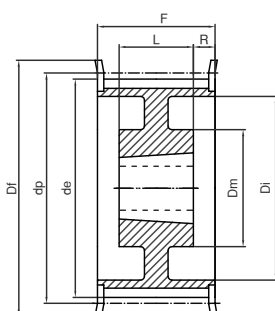

19F

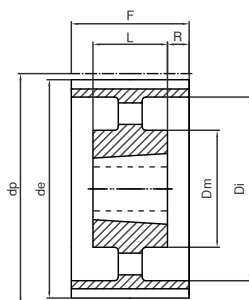

20

Ref.	Material	Z	Taper	Ø max.	dp	de	Df	Dm	Di	F	L	R	Fig.	Kg.
TL2814M40	St	28	2012	50	124,78	122,12	127		94	54	32	11	18F	2,10
TL3014M40	St	30	2012	50	133,69	130,99	138		98	54	32	11	18F	2,70
TL3214M40	St	32	2012	50	142,60	139,88	154		108	54	32	11	18F	3,40
TL3414M40	St	34	2517	60	151,52	148,79	160		110	54	45	4,5	18F	3,90
TL3614M40	St	36	2517	60	160,43	157,68	168		120	54	45	4,5	18F	4,80
TL3814M40	St	38	2517	60	169,34	166,60	183		130	54	45	4,5	18F	5,40
TL4014M40	St	40	2517	60	178,25	175,49	188		138	54	45	4,5	18F	6,00
TL4414M40	St	44	3020	75	196,08	193,28	211		155	54	51	1,5	18F	7,50
TL4814M40	St	48	3020	75	213,90	211,11	226		170	54	51	1,5	18F	8,50
TL5614M40	GG	56	3020	75	249,55	246,76	256		208	54	51	1,5	18F	10,10
TL6414M40	GG	64	3020	75	285,21	282,41	296	170	240	54	51	1,5	19F	13,40
TL7214M40	GG	72	3020	75	320,86	318,06		170	280	54	51	1,5	19	15,00
TL8014M40	GG	80	3020	75	356,51	353,71		170	315	54	51	1,5	20	16,00
TL9014M40	GG	90	3020	75	401,07	398,28		170	360	54	51	1,5	20	18,00
TL11214M40	GG	112	3020	75	499,11	496,32		170	457	54	51	1,5	20	25,50
TL14414M40	GG	144	3020	75	641,71	638,92		170	600	54	51	1,5	20	32,00
TL16814M40	GG	168	3020	75	748,66	745,87		170	706	54	51	1,5	20	43,50
TL19214M40	GG	192	3020	75	855,62	852,82		170	813	54	51	1,5	20	49,50

Material: Acero/Steel/Acier (St)
 Material: Fundición/Cast iron/Fonte (GG)

POLEAS DENTADAS HTD PARA TAPER

HTD taper bored timing belt pulleys

Poulies dentées HTD pour moyeu amovible

14M-55

mm

Paso 14
Pitch 14
Pas 14

Para correas de ancho 55
For belt width 55
Pour courroies largeur 55

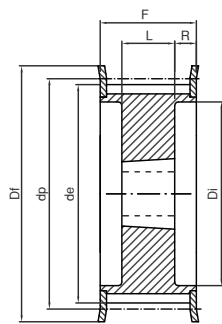

18F

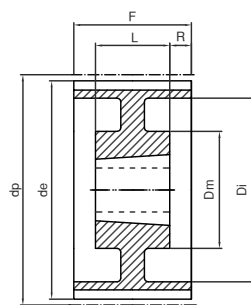

19

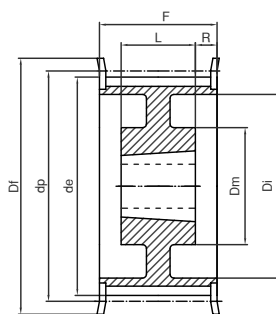

19F

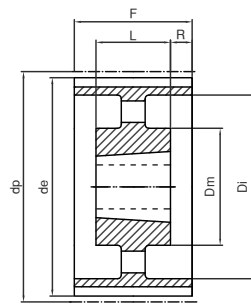

20

Ref.	Material	Z	Taper	Ø max.	dp	de	Df	Dm	Di	F	L	R	Fig.	Kg.
TL2814M55	St	28	2012	50	124,78	122,12	127	94	70	32	19	18F	2,20	
TL3014M55	St	30	2517	60	133,69	130,99	138	100	70	45	12,5	18F	2,70	
TL3214M55	St	32	2517	60	142,60	139,88	154	108	70	45	12,5	18F	3,60	
TL3414M55	St	34	2517	60	151,52	148,79	160	110	70	45	12,5	18F	4,50	
TL3614M55	St	36	2517	60	160,43	157,68	168	120	70	45	12,5	18F	5,20	
TL3814M55	St	38	2517	60	169,34	166,60	183	130	70	45	12,5	18F	6,20	
TL4014M55	St	40	2517	60	178,25	175,49	188	138	70	45	12,5	18F	6,90	
TL4414M55	St	44	3020	75	196,08	193,28	211	155	70	51	9,5	18F	8,60	
TL4814M55	St	48	3020	75	213,90	211,11	226	170	70	51	9,5	18F	10,50	
TL5614M55	GG	56	3020	75	249,55	246,76	256	208	70	51	9,5	18F	13,50	
TL6414M55	GG	64	3020	75	285,21	282,41	296	170	240	70	51	9,5	19F	14,50
TL7214M55	GG	72	3020	75	320,86	318,06		170	280	70	51	9,5	19	16,30
TL8014M55	GG	80	3020	75	356,51	353,71		170	315	70	51	9,5	20	17,50
TL9014M55	GG	90	3020	75	401,07	398,28		170	360	70	51	9,5	20	20,00
TL11214M55	GG	112	3020	75	499,11	496,32		170	457	70	51	9,5	20	28,20
TL14414M55	GG	144	3020	75	641,71	638,92		170	600	70	51	9,5	20	36,00
TL16814M55	GG	168	3020	75	748,66	745,87		170	706	70	51	9,5	20	48,50
TL19214M55	GG	192	3020	75	855,62	852,82		170	813	70	51	9,5	20	52,00

Material: Acero/Steel/Acier (St)
Material: Fundición/Cast iron/Fonete (GG)

POLEAS DENTADAS HTD PARA TAPER

HTD taper bored timing belt pulleys

Poulies dentées HTD pour moyeu amovible

14M-85

mm

Paso 14
Pitch
Pas

Para correas de ancho 85
For belt width
Pour courroies largeur

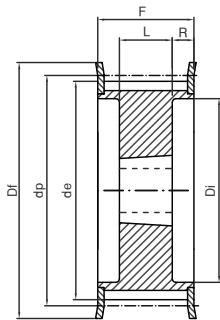

18F

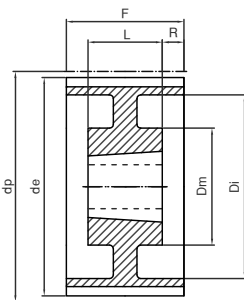

19

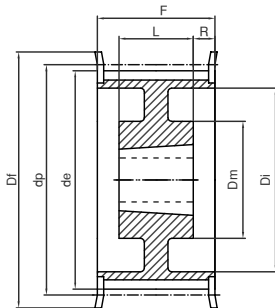

19F

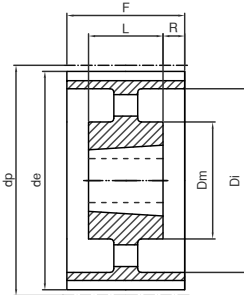

20

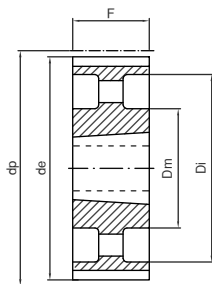

22

Material: Acero/Steel/Acier (St)

Material: Fundición/Cast iron/Fonte (GG)

Ref.	Material	Z	Taper	Ø max.	dp	de	Df	Dm	Di	F	L	R	Fig.	Kg.
TL2814M85	St	28	2517	60	124,78	122,12	127	98	102	45	28,5	18F		2,70
TL3014M85	St	30	2517	60	133,69	130,99	138	100	102	45	28,5	18F		3,80
TL3214M85	St	32	2517	60	142,60	139,88	154	108	102	45	28,5	18F		4,70
TL3414M85	St	34	2517	60	151,52	148,79	160	110	102	45	28,5	18F		6,00
TL3614M85	St	36	3020	75	160,43	157,68	168	125	102	51	25,5	18F		5,70
TL3814M85	St	38	3020	75	169,34	166,60	183	130	102	51	25,5	18F		6,80
TL4014M85	St	40	3020	75	178,25	175,49	188	138	102	51	25,5	18F		8,00
TL4414M85	St	44	3030	75	196,08	193,28	211	155	102	76	13	18F		11,70
TL4814M85	St	48	3030	75	213,90	211,11	226	170	102	76	13	18F		15,00
TL5614M85	GG	56	3525	90	249,55	246,76	256	210	102	65	18,5	18F		19,00
TL6414M85	GG	64	3525	90	285,21	282,41	296	190	240	102	65	18,5	19F	23,50
TL7214M85	GG	72	3525	90	320,86	318,06		190	280	102	65	18,5	19	25,00
TL8014M85	GG	80	3525	90	356,51	353,71		190	315	102	65	18,5	20	26,00
TL9014M85	GG	90	3525	90	401,07	398,28		190	360	102	65	18,5	20	28,00
TL11214M85	GG	112	3525	90	499,11	496,32		190	457	102	65	18,5	20	36,00
TL14414M85	GG	144	3525	90	641,71	638,92		190	600	102	65	18,5	20	48,00
TL16814M85	GG	168	3525	90	748,66	745,87		190	706	102	65	18,5	20	60,00
TL19214M85	GG	192	4040	100	855,62	852,82		230	813	102	102		22	85,00

POLEAS DENTADAS HTD PARA TAPER

HTD taper bored timing belt pulleys

Poulies dentées HTD pour moyeu amovible

14M-115

mm

Paso

14

Pitch

Pas

Para correas de ancho

115

For belt width

Pour courroies largeur

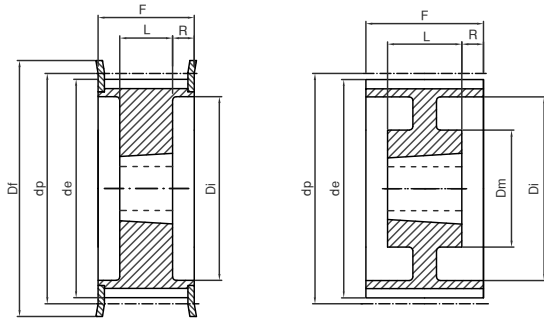

18F

19

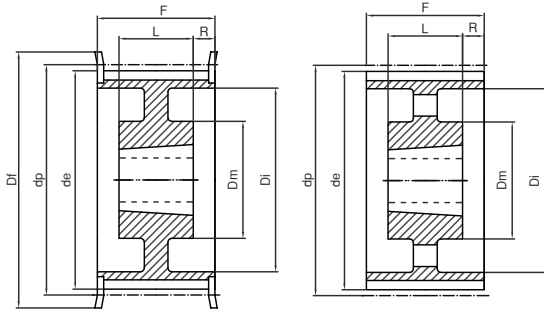

19F

20

Ref.	Material	Z	Taper	Ø max.	dp	de	Df	Dm	Di	F	L	R	Fig.	Kg.
TL2814M115	St	28	2517	60	124,78	122,12	127	98	133	45	44	18F	3,80	
TL3014M115	St	30	2517	60	133,69	130,99	138	100	133	45	44	18F	5,00	
TL3214M115	St	32	2517	60	142,60	139,88	154	108	133	45	44	18F	6,80	
TL3414M115	St	34	2517	60	151,52	148,79	160	110	133	45	44	18F	6,90	
TL3614M115	St	36	3020	75	160,43	157,68	168	125	133	51	41	18F	7,00	
TL3814M115	St	38	3020	75	169,34	166,60	183	130	133	51	41	18F	8,50	
TL4014M115	St	40	3020	75	178,25	175,49	188	138	133	51	41	18F	9,10	
TL4414M115	St	44	3030	75	196,08	193,28	211	155	133	76	28,5	18F	13,00	
TL4814M115	St	48	3030	75	213,90	211,11	226	170	133	76	28,5	18F	16,00	
TL5614M115	GG	56	3535	90	249,55	246,76	256	210	133	89	22	18F	24,00	
TL6414M115	GG	64	3535	90	285,21	282,41	296	190	240	133	89	22	19F	32,00
TL7214M115	GG	72	3535	90	320,86	318,06		190	280	133	89	22	19	31,00
TL8014M115	GG	80	3535	90	356,51	353,71		190	315	133	89	22	20	32,00
TL9014M115	GG	90	3535	90	401,07	398,28		190	360	133	89	22	20	37,00
TL11214M115	GG	112	3535	90	499,11	496,32		190	457	133	89	22	20	45,00
TL14414M115	GG	144	4040	100	641,71	638,92		230	600	133	102	15,5	20	63,00
TL16814M115	GG	168	4040	100	748,66	745,87		230	706	133	102	15,5	20	77,50
TL19214M115	GG	192	4040	100	855,62	852,82		230	813	133	102	15,5	20	95,00

Material: Acero/Steel/Acier (St)

Material: Fundición/Cast iron/Fonte (GG)

POLEAS DENTADAS HTD PARA TAPER

HTD taper bored timing belt pulleys
Poulies dentées HTD pour moyeu amovible

14M-170 mm

Paso 14
 Pitch
Pas

Para correas de ancho 170
 For belt width
Pour courroies largeur

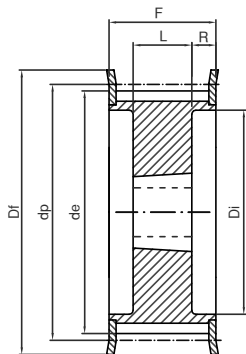

18F

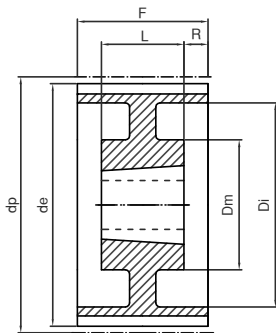

19

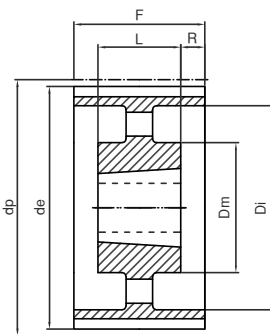

20

Ref.	Material	Z	Taper	Ø max.	dp	de	Df	Dm	Di	F	L	R	Fig.	Kg.
TL3814M170	St	38	3030	75	169,34	166,60	183		130	187	76	55,5	18F	11,70
TL4014M170	St	40	3030	75	178,25	175,49	188		138	187	76	55,5	18F	13,00
TL4414M170	St	44	3535	90	196,08	193,28	211		155	187	89	49	18F	15,00
TL4814M170	St	48	3535	90	213,90	211,11	226		170	187	89	49	18F	19,00
TL5614M170	St	56	3535	90	249,55	246,76	256		210	187	89	49	18F	28,50
TL6414M170	GG	64	4040	100	285,21	282,41	296		240	187	102	42,5	18F	41,00
TL7214M170	GG	72	4040	100	320,86	318,06		230	280	187	102	42,5	19	47,00
TL8014M170	GG	80	4040	100	356,51	353,71		230	315	187	102	42,5	19	48,00
TL9014M170	GG	90	4040	100	401,07	398,28		230	360	187	102	42,5	20	52,50
TL11214M170	GG	112	5050	125	499,11	496,32		265	457	187	127	30	20	74,50
TL14414M170	GG	144	5050	125	641,71	638,92		265	600	187	127	30	20	91,00
TL16814M170	GG	168	5050	125	748,66	745,87		265	706	187	127	30	20	116,00
TL19214M170	GG	192	5050	125	855,62	852,82		265	813	187	127	30	20	134,00

Material: Acero/Steel/Acier (St)
 Material: Fundición/Cast iron/Fonte (GG)

POLEAS DENTADAS SERIE “T”

“T” timing belt pulleys

*Poulies dentées série “T”***16T 2,5**

mm

Paso 2,5
Pitch
Pas

Para correas de ancho 6
For belt width
Pour courroies largeur

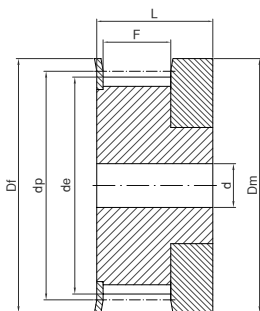

1F

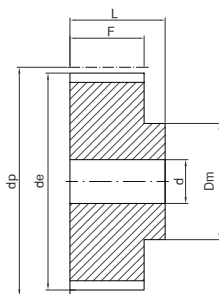

2

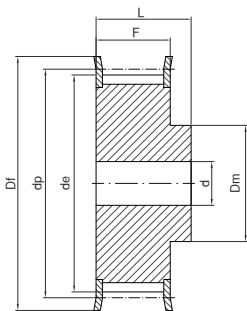

2F

Ref.	Material	Z	de	Df	Dm	F	L	d	Fig.	Kg.
16T2,512	Al	12	9,00	13	12	9	16		1F	0,01
16T2,514	Al	14	10,60	15	14	9	16		1F	0,01
16T2,515	Al	15	11,40	15	15	9	16		1F	0,01
16T2,516	Al	16	12,20	16	16	9	16		1F	0,01
16T2,518	Al	18	13,80	18	10	10	16	3	2F	0,01
16T2,519	Al	19	14,60	18	10	10	16	3	2F	0,01
16T2,520	Al	20	15,40	19,5	11	10	16	3	2F	0,01
16T2,522	Al	22	17,00	23	11	10	16	3	2F	0,01
16T2,524	Al	24	18,55	23	12	10	16	3	2F	0,01
16T2,525	Al	25	19,35	23	13	10	16	3	2F	0,01
16T2,526	Al	26	20,15	25	14	10	16	4	2F	0,01
16T2,528	Al	28	21,75	25	14	10	16	4	2F	0,02
16T2,530	Al	30	23,35	28	16	10	16	6	2F	0,02
16T2,532	Al	32	24,95	32	16	10	16	6	2F	0,02
16T2,536	Al	36	28,10	36	20	10	16	6	2F	0,03
16T2,540	Al	40	31,30	38	22	10	16	6	2F	0,03
16T2,544	Al	44	34,50		24	10	16	6	2	0,04
16T2,548	Al	48	37,70		26	10	16	6	2	0,05
16T2,560	Al	60	47,25		34	10	16	8	2	0,07

Material: Aluminio/Aluminium UNI 9006 - T6 (Al)

POLEAS DENTADAS SERIE "T"

"T" timing belt pulleys

Poulies dentées série "T"

21T 5

mm

Paso 5
Pitch 5
Pas 5

Para correas de ancho 10
For belt width 10
Pour courroies largeur 10

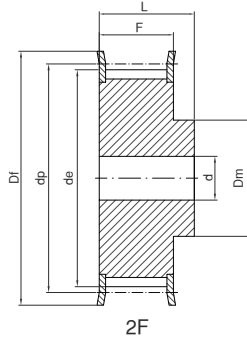
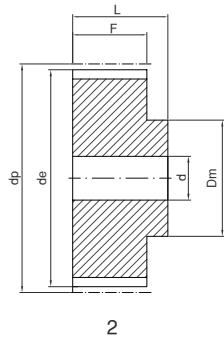

Ref.	Material	Z	de	Df	Dm	F	L	d	Fig.	Kg.
21T510	Al	10	15,05	19,5	8	15	21		2F	0,01
21T512	Al	12	18,25	23	10	15	21		2F	0,01
21T514	Al	14	21,45	25	13	15	21		2F	0,02
21T515	Al	15	23,05	28	16	15	21		2F	0,02
21T516	Al	16	24,60	32	18	15	21		2F	0,03
21T518	Al	18	27,80	32	20	15	21		2F	0,03
21T519	Al	19	29,40	36	22	15	21		2F	0,04
21T520	Al	20	31,00	36	23	15	21		2F	0,04
21T522	Al	22	34,25	38	24	15	21		2F	0,05
21T524	Al	24	37,40	42	26	15	21		2F	0,06
21T525	Al	25	38,95	44	26	15	21		2F	0,06
21T526	Al	26	40,60	44	26	15	21		2F	0,06
21T527	Al	27	42,20	48	30	15	21	8	2F	0,07
21T528	Al	28	43,75	48	32	15	21	8	2F	0,07
21T530	Al	30	46,95	51	34	15	21	8	2F	0,07
21T532	Al	32	50,10	54	38	15	21	8	2F	0,09
21T536	Al	36	56,45	63	38	15	21	8	2F	0,11
21T540	Al	40	62,85	66	40	15	21	8	2F	0,14
21T542	Al	42	66,00	71	40	15	21	8	2F	0,18
21T544	Al	44	69,20		45	15	21	8	2	0,18
21T548	Al	48	75,55		50	15	21	8	2	0,20
21T560	Al	60	94,65		65	15	21	8	2	0,31

POLEAS DENTADAS SERIE “T”
 “T” timing belt pulleys
 Poulies dentées série “T”

27T 5 mm

Paso 5
 Pitch
 Pas

Para correas de ancho 16
 For belt width
 Pour courroies largeur

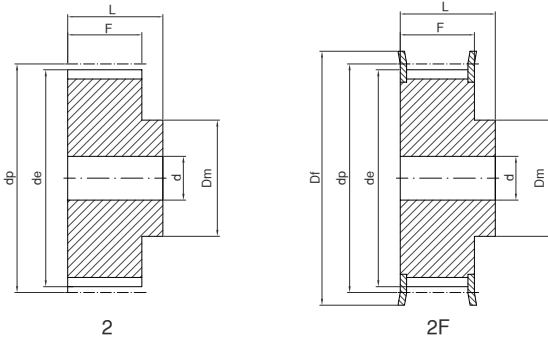

Ref.	Material	Z	de	Df	Dm	F	L	d	Fig.	Kg.
27T510	Al	10	15,05	19,5	8	21	27		2F	0,02
27T512	Al	12	18,25	23	10	21	27		2F	0,02
27T514	Al	14	21,45	25	13	21	27		2F	0,03
27T515	Al	15	23,05	28	16	21	27		2F	0,03
27T516	Al	16	24,60	32	18	21	27		2F	0,04
27T518	Al	18	27,80	32	20	21	27		2F	0,04
27T519	Al	19	29,40	36	22	21	27		2F	0,05
27T520	Al	20	31,00	36	23	21	27		2F	0,06
27T522	Al	22	34,25	38	24	21	27		2F	0,06
27T524	Al	24	37,40	42	26	21	27		2F	0,08
27T525	Al	25	38,95	44	26	21	27		2F	0,08
27T526	Al	26	40,60	44	26	21	27		2F	0,09
27T527	Al	27	42,20	48	30	21	27	8	2F	0,09
27T528	Al	28	43,75	48	32	21	27	8	2F	0,09
27T530	Al	30	46,95	51	34	21	27	8	2F	0,10
27T532	Al	32	50,10	54	38	21	27	8	2F	0,12
27T536	Al	36	56,45	63	38	21	27	8	2F	0,16
27T540	Al	40	62,85	66	40	21	27	8	2F	0,19
27T542	Al	42	66,00	71	40	21	27	8	2F	0,20
27T544	Al	44	69,20		45	21	27	8	2	0,23
27T548	Al	48	75,55		50	21	27	8	2	0,28
27T560	Al	60	94,65		65	21	27	8	2	0,43

Material: Aluminio/Aluminium UNI 9006 - T6 (Al)

POLEAS DENTADAS SERIE "T"

"T" timing belt pulleys
 Poulies dentées série "T"

36T 5

mm

Paso 5
 Pitch
 Pas

Para correas de ancho 25
 For belt width
 Pour courroies largeur

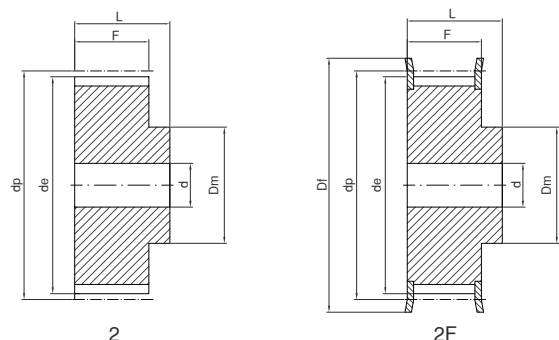

Ref.	Material	Z	de	Df	Dm	F	L	d	Fig.	Kg.
36T510	Al	10	15,05	19,5	8	30	36		2F	0,02
36T512	Al	12	18,25	23	10	30	36		2F	0,03
36T514	Al	14	21,45	25	13	30	36		2F	0,04
36T515	Al	15	23,05	28	16	30	36		2F	0,04
36T516	Al	16	24,60	32	18	30	36		2F	0,05
36T518	Al	18	27,80	32	20	30	36		2F	0,06
36T519	Al	19	29,40	36	22	30	36		2F	0,07
36T520	Al	20	31,00	36	23	30	36		2F	0,08
36T522	Al	22	34,25	38	24	30	36		2F	0,08
36T524	Al	24	37,40	42	26	30	36		2F	0,11
36T525	Al	25	38,95	44	26	30	36		2F	0,12
36T526	Al	26	40,60	44	26	30	36		2F	0,12
36T527	Al	27	42,20	48	30	30	36	8	2F	0,13
36T528	Al	28	43,75	48	32	30	36	8	2F	0,14
36T530	Al	30	46,95	51	34	30	36	8	2F	0,15
36T532	Al	32	50,10	54	38	30	36	8	2F	0,18
36T536	Al	36	56,45	63	38	30	36	8	2F	0,23
36T540	Al	40	62,85	66	40	30	36	8	2F	0,28
36T542	Al	42	66,00	71	40	30	36	8	2F	0,29
36T544	Al	44	69,20		45	30	36	8	2	0,31
36T548	Al	48	75,55		50	30	36	8	2	0,40
36T560	Al	60	94,65		65	30	36	8	2	0,61

POLEAS DENTADAS SERIE "T"

"T" timing belt pulleys

Poulies dentées série "T"

31T 10

mm

Paso

10

Pitch

Pas

Para correas de ancho

16

For belt width

Pour courroies largeur

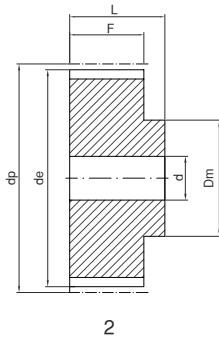

2

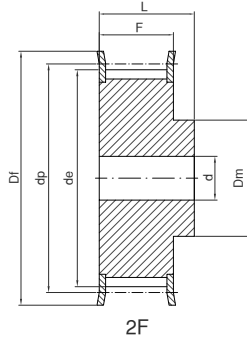

2F

Ref.	Material	Z	de	Df	Dm	F	L	d	Fig.	Kg.
31T1012	Al	12	36,35	42	28	21	31	6	2F	0,08
31T1014	Al	14	42,70	48	32	21	31	8	2F	0,10
31T1015	Al	15	45,90	51	32	21	31	8	2F	0,12
31T1016	Al	16	49,10	54	35	21	31	8	2F	0,13
31T1018	Al	18	55,45	60	40	21	31	8	2F	0,17
31T1019	Al	19	58,65	66	44	21	31	8	2F	0,18
31T1020	Al	20	61,80	66	46	21	31	8	2F	0,21
31T1022	Al	22	68,20	75	52	21	31	8	2F	0,25
31T1024	Al	24	74,55	83	58	21	31	8	2F	0,29
31T1025	Al	25	77,75	83	60	21	31	8	2F	0,31
31T1026	Al	26	80,90	87	60	21	31	8	2F	0,36
31T1027	Al	27	84,10	91	60	21	31	8	2F	0,37
31T1028	Al	28	87,25	93	60	21	31	8	2F	0,40
31T1030	Al	30	93,65	97	60	21	31	8	2F	0,44
31T1032	Al	32	100,00	106	65	21	31	10	2F	0,49
31T1036	Al	36	112,75	119	70	21	31	10	2F	0,62
31T1040	Al	40	125,45	131	80	21	31	10	2F	0,77
31T1044	Al	44	138,20		88	21	31	10	2	1,00
31T1048	Al	48	150,95		95	21	31	16	2	1,10
31T1060	Al	60	189,15		110	21	31	16	2	1,70

POLEAS DENTADAS SERIE “T”

“T” timing belt pulleys

*Poulies dentées série “T”***47T 10**

mm

Paso 10
Pitch
Pas

Para correas de ancho 32
For belt width
Pour courroies largeur

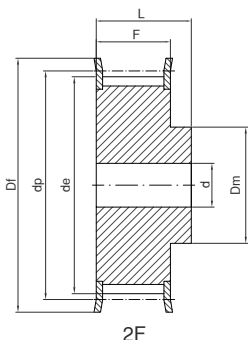
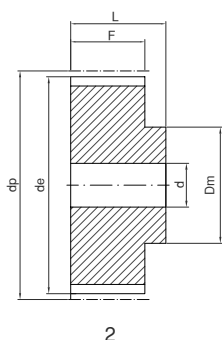

Ref.	Material	Z	de	Df	Dm	F	L	d	Fig.	Kg.
47T1018	Al	18	55,45	60	40	37	47	10	2F	0,25
47T1019	Al	19	58,65	66	44	37	47	10	2F	0,29
47T1020	Al	20	61,80	66	46	37	47	12	2F	0,32
47T1022	Al	22	68,20	75	52	37	47	12	2F	0,39
47T1024	Al	24	74,55	83	58	37	47	12	2F	0,47
47T1025	Al	25	77,75	83	60	37	47	12	2F	0,53
47T1026	Al	26	80,90	87	60	37	47	12	2F	0,56
47T1027	Al	27	84,10	91	60	37	47	12	2F	0,60
47T1028	Al	28	87,25	93	60	37	47	12	2F	0,64
47T1030	Al	30	93,65	97	60	37	47	12	2F	0,74
47T1032	Al	32	100,00	106	65	37	47	12	2F	0,84
47T1036	Al	36	112,75	119	70	37	47	16	2F	1,06
47T1040	Al	40	125,45	131	80	37	47	16	2F	1,32
47T1044	Al	44	138,20		88	37	47	16	2	1,61
47T1048	Al	48	150,95		95	37	47	16	2	1,93
47T1060	Al	60	189,10		110	37	47	16	2	3,00

Material: Aluminio/Aluminium UNI 9006 - T6 (Al)

POLEAS DENTADAS SERIE "T"**"T" timing belt pulleys*****Poulies dentées série "T"*****66T 10**

mm

Paso
Pitch
Pas

10

Para correas de ancho
For belt width
Pour courroies largeur

50

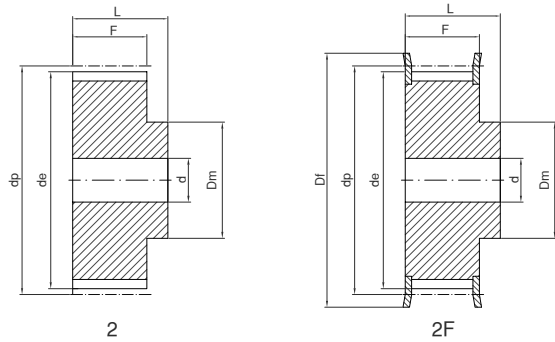

Ref.	Material	Z	de	Df	Dm	F	L	d	Fig.	Kg.
66T1018	Al	18	55,45	60	40	56	66	10	2F	0,42
66T1019	Al	19	58,65	66	44	56	66	10	2F	0,47
66T1020	Al	20	61,80	66	46	56	66	12	2F	0,52
66T1022	Al	22	68,20	75	52	56	66	12	2F	0,57
66T1024	Al	24	74,55	83	58	56	66	12	2F	0,74
66T1025	Al	25	77,75	83	60	56	66	12	2F	0,77
66T1026	Al	26	80,90	87	60	56	66	12	2F	0,82
66T1027	Al	27	84,10	91	60	56	66	12	2F	0,95
66T1028	Al	28	87,25	93	60	56	66	12	2F	0,96
66T1030	Al	30	93,65	97	60	56	66	12	2F	1,17
66T1032	Al	32	100,00	106	65	56	66	12	2F	1,30
66T1036	Al	36	112,75	119	70	56	66	16	2F	1,64
66T1040	Al	40	125,45	131	80	56	66	16	2F	2,00
66T1044	Al	44	138,20		88	56	66	16	2	2,36
66T1048	Al	48	150,95		95	56	66	16	2	2,83
66T1060	Al	60	189,10		110	56	66	16	2	4,37

POLEAS DENTADAS SERIE "T"

"T" timing belt pulleys

Poulies dentées série "T"

21AT 5

Paso
Pitch
Pas

mm

5

Para correas de ancho
For belt width
Pour courroies largeur

10

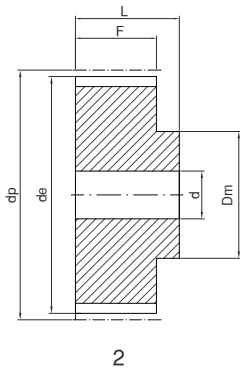
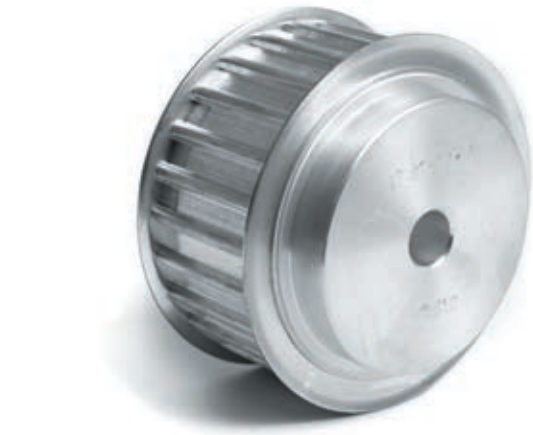

2

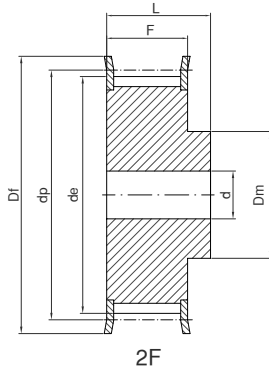

2F

Ref.	Material	Z	de	Df	Dm	F	L	d	Fig.	Kg.
21AT512	Al	12	17,85	23	10	15	21		2F	0,01
21AT514	Al	14	21,05	25	13	15	21		2F	0,02
21AT515	Al	15	22,65	28	16	15	21		2F	0,02
21AT516	Al	16	24,20	32	18	15	21		2F	0,03
21AT518	Al	18	27,40	32	20	15	21		2F	0,03
21AT519	Al	19	29,00	36	22	15	21		2F	0,04
21AT520	Al	20	30,60	36	23	15	21		2F	0,04
21AT522	Al	22	33,85	38	24	15	21		2F	0,05
21AT524	Al	24	37,00	42	26	15	21		2F	0,06
21AT525	Al	25	38,55	44	26	15	21		2F	0,06
21AT526	Al	26	40,20	44	26	15	21		2F	0,06
21AT527	Al	27	41,80	48	30	15	21	8	2F	0,07
21AT528	Al	28	43,35	48	32	15	21	8	2F	0,07
21AT530	Al	30	46,55	51	34	15	21	8	2F	0,07
21AT532	Al	32	49,70	54	38	15	21	8	2F	0,09
21AT536	Al	36	56,05	63	38	15	21	8	2F	0,11
21AT540	Al	40	62,45	66	40	15	21	8	2F	0,14
21AT542	Al	42	65,60	71	40	15	21	8	2F	0,18
21AT544	Al	44	68,80		45	15	21	8	2	0,18
21AT548	Al	48	75,15		50	15	21	8	2	0,20
21AT560	Al	60	94,25		65	15	21	8	2	0,31

POLEAS DENTADAS SERIE "AT"

"AT" timing belt pulleys

Poulies dentées série "AT"

27AT 5

mm

Paso

5

Pitch

Pas

Para correas de ancho

16

For belt width

Pour courroies largeur

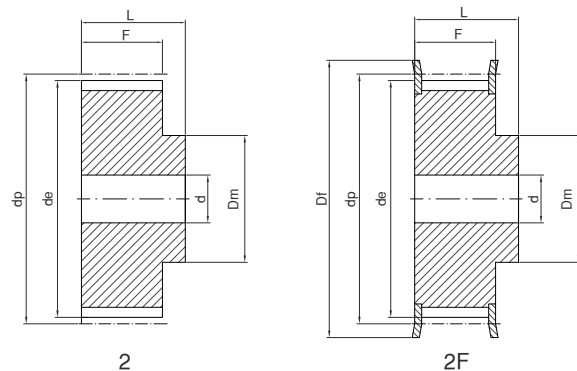

Ref.	Material	Z	de	Df	Dm	F	L	d	Fig.	Kg.
27AT512	Al	12	17,85	23	10	21	27		2F	0,02
27AT514	Al	14	21,05	25	13	21	27		2F	0,03
27AT515	Al	15	22,65	28	16	21	27		2F	0,03
27AT516	Al	16	24,20	32	18	21	27		2F	0,04
27AT518	Al	18	27,40	32	20	21	27		2F	0,04
27AT519	Al	19	29,00	36	22	21	27		2F	0,05
27AT520	Al	20	30,60	36	23	21	27		2F	0,06
27AT522	Al	22	33,85	38	24	21	27		2F	0,06
27AT524	Al	24	37,00	42	26	21	27		2F	0,08
27AT525	Al	25	38,55	44	26	21	27		2F	0,08
27AT526	Al	26	40,20	44	26	21	27		2F	0,09
27AT527	Al	27	41,80	48	30	21	27	8	2F	0,09
27AT528	Al	28	43,35	48	32	21	27	8	2F	0,09
27AT530	Al	30	46,55	51	34	21	27	8	2F	0,10
27AT532	Al	32	49,70	54	38	21	27	8	2F	0,12
27AT536	Al	36	56,05	63	38	21	27	8	2F	0,16
27AT540	Al	40	62,45	66	40	21	27	8	2F	0,19
27AT542	Al	42	65,60	71	40	21	27	8	2F	0,20
27AT544	Al	44	68,80		45	21	27	8	2	0,23
27AT548	Al	48	75,15		50	21	27	8	2	0,28
27AT560	Al	60	94,25		65	21	27	8	2	0,43

POLEAS DENTADAS SERIE "AT"

"AT" timing belt pulleys

Poulies dentées série "AT"

36AT 5

mm

Paso
Pitch
Pas

5

Para correas de ancho
For belt width
Pour courroies largeur

25

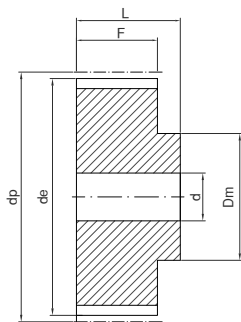

2

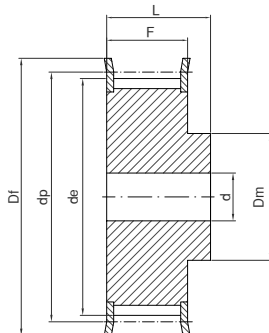

2F

Ref.	Material	Z	de	Df	Dm	F	L	d	Fig.	Kg.
36AT512	Al	12	17,85	23	10	30	36		2F	0,03
36AT514	Al	14	21,05	25	13	30	36		2F	0,04
36AT515	Al	15	22,65	28	16	30	36		2F	0,04
36AT516	Al	16	24,20	32	18	30	36		2F	0,05
36AT518	Al	18	27,40	32	20	30	36		2F	0,06
36AT519	Al	19	29,00	36	22	30	36		2F	0,07
36AT520	Al	20	30,60	36	23	30	36		2F	0,08
36AT522	Al	22	33,85	38	24	30	36		2F	0,08
36AT524	Al	24	37,00	42	26	30	36	8	2F	0,11
36AT525	Al	25	38,55	44	26	30	36	8	2F	0,12
36AT526	Al	26	40,20	44	26	30	36	8	2F	0,12
36AT527	Al	27	41,80	48	30	30	36	8	2F	0,13
36AT528	Al	28	43,35	48	32	30	36	8	2F	0,14
36AT530	Al	30	46,55	51	34	30	36	8	2F	0,15
36AT532	Al	32	49,70	54	38	30	36	8	2F	0,18
36AT536	Al	36	56,05	63	38	30	36	8	2F	0,23
36AT540	Al	40	62,45	66	40	30	36	8	2F	0,28
36AT542	Al	42	65,60	71	40	30	36	8	2F	0,29
36AT544	Al	44	68,80		45	30	36	8	2	0,31
36AT548	Al	48	75,15		50	30	36	8	2	0,40
36AT560	Al	60	94,25		65	30	36	8	2	0,61

POLEAS DENTADAS SERIE "AT"

"AT" timing belt pulleys

Poulies dentées série "AT"

31AT 10 mm

Paso 10
 Pitch
 Pas

Para correas de ancho 16
 For belt width
 Pour courroies largeur

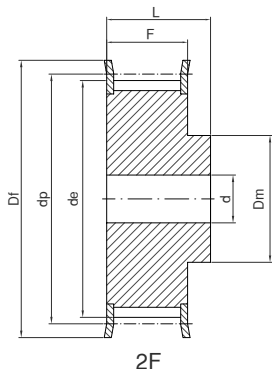
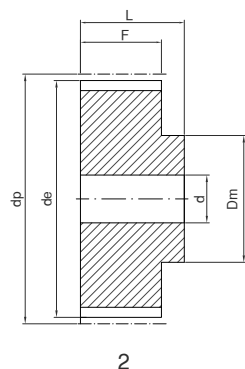

Ref.	Material	Z	de	Df	Dm	F	L	d	Fig.	Kg.
31AT1015	Al	15	45,90	51	32	21	31	8	2F	0,12
31AT1016	Al	16	49,10	54	35	21	31	8	2F	0,13
31AT1018	Al	18	55,45	60	40	21	31	8	2F	0,17
31AT1019	Al	19	58,65	66	44	21	31	8	2F	0,18
31AT1020	Al	20	61,80	66	46	21	31	8	2F	0,21
31AT1022	Al	22	68,20	75	52	21	31	8	2F	0,25
31AT1024	Al	24	74,55	83	58	21	31	8	2F	0,29
31AT1025	Al	25	77,75	83	60	21	31	8	2F	0,31
31AT1026	Al	26	80,90	87	60	21	31	8	2F	0,36
31AT1027	Al	27	84,05	91	60	21	31	8	2F	0,37
31AT1028	Al	28	87,25	93	60	21	31	8	2F	0,40
31AT1030	Al	30	93,65	97	60	21	31	8	2F	0,44
31AT1032	Al	32	100,00	106	65	21	31	10	2F	0,49
31AT1036	Al	36	112,75	119	70	21	31	10	2F	0,62
31AT1040	Al	40	125,45	131	80	21	31	10	2F	0,77
31AT1044	Al	44	138,20		88	21	31	10	2	1,00
31AT1048	Al	48	150,95		95	21	31	16	2	1,10
31AT1060	Al	60	189,15		110	21	31	16	2	1,70

Material: Aluminio/Aluminium UNI 9006 - T6 (Al)

POLEAS DENTADAS SERIE “AT”

“AT” timing belt pulleys
 Poulies dentées série “AT”

40AT 10 mm

Paso Pitch 10
 Pitch Pas

Para correas de ancho 25
 For belt width
 Pour courroies largeur

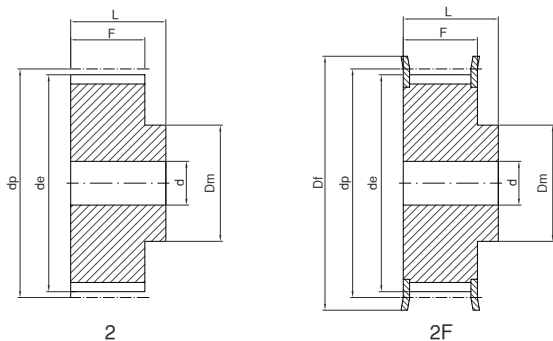

Ref.	Material	Z	de	Df	Dm	F	L	d	Fig.	Kg.
40AT1015	Al	15	45,90	51	32	30	40	8	2F	0,15
40AT1016	Al	16	49,10	54	35	30	40	8	2F	0,18
40AT1018	Al	18	55,45	60	40	30	40	8	2F	0,22
40AT1019	Al	19	58,65	66	44	30	40	8	2F	0,25
40AT1020	Al	20	61,80	66	46	30	40	8	2F	0,28
40AT1022	Al	22	68,20	75	52	30	40	8	2F	0,34
40AT1024	Al	24	74,55	83	58	30	40	8	2F	0,39
40AT1025	Al	25	77,75	83	60	30	40	8	2F	0,42
40AT1026	Al	26	80,90	87	60	30	40	8	2F	0,48
40AT1027	Al	27	84,05	91	60	30	40	8	2F	0,54
40AT1028	Al	28	87,25	93	60	30	40	8	2F	0,55
40AT1030	Al	30	93,65	97	60	30	40	8	2F	0,64
40AT1032	Al	32	100,00	106	65	30	40	10	2F	0,69
40AT1036	Al	36	112,75	119	70	30	40	10	2F	0,87
40AT1040	Al	40	125,45	131	80	30	40	10	2F	1,07
40AT1044	Al	44	138,20		88	30	40	10	2	1,35
40AT1048	Al	48	150,95		95	30	40	16	2	1,52
40AT1060	Al	60	189,15		110	30	40	16	2	2,34

Material: Aluminio/Aluminium UNI 9006 - T6 (Al)

POLEAS DENTADAS SERIE "AT"

"AT" timing belt pulleys

Poulies dentées série "AT"

66AT 10

mm

Paso 10

Pitch

Pas

Para correas de ancho 50

For belt width

Pour courroies largeur

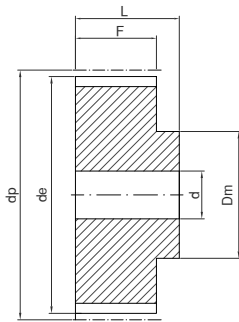

2

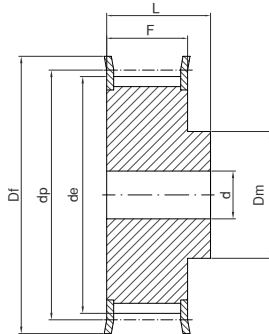

2F

Ref.	Material	Z	de	Df	Dm	F	L	d	Fig.	Kg.
66AT1018	Al	18	55,45	60	40	56	66	10	2F	0,42
66AT1019	Al	19	58,65	66	44	56	66	10	2F	0,47
66AT1020	Al	20	61,80	66	46	56	66	12	2F	0,52
66AT1022	Al	22	68,20	75	52	56	66	12	2F	0,57
66AT1024	Al	24	74,55	83	58	56	66	12	2F	0,74
66AT1025	Al	25	77,75	83	60	56	66	12	2F	0,77
66AT1026	Al	26	80,90	87	60	56	66	12	2F	0,82
66AT1027	Al	27	84,05	91	60	56	66	12	2F	0,95
66AT1028	Al	28	87,25	93	60	56	66	12	2F	0,96
66AT1030	Al	30	93,65	97	60	56	66	12	2F	1,17
66AT1032	Al	32	100,00	106	65	56	66	12	2F	1,30
66AT1036	Al	36	112,75	119	70	56	66	16	2F	1,64
66AT1040	Al	40	125,45	131	80	56	66	16	2F	2,00
66AT1044	Al	44	138,20		88	56	66	16	2	2,36
66AT1048	Al	48	150,95		95	56	66	16	2	2,83
66AT1060	Al	60	189,15		110	56	66	16	2	4,37

Material: Aluminio/Aluminium UNI 9006 - T6 (Al)

